



The Evergreen of enclosure technology

Standard enclosures made of aluminium, polycarbonate, ABS and polyester

Our service for your Smart Factory

BERNSTEIN AG, headquartered on the banks of the River Weser in Porta Westfalica, Germany - the "Westfälische Pforte" (Westphalian Gate) between the Weser and the Wiehengebirge mountains – can look back on an eventful past that is directly linked to Germany's most recent history. It was here, in 1947, that Hans Bernstein founded the "Hans Bernstein Spezialfabrik für Schaltkontakte", company from which BERNSTEIN AG emerged. The family owned company is now in the hands of the third generation, operates internationally, and employs more than 500 people in 10 countries.

In-depth market knowledge, at close proximity to end users, and years of experience in mechanical engineering and electronics are reflected down to the last detail in our products. Against this backdrop, BERNSTEIN ranks among the world's leading providers of industrial safety and enclosure technology. With our comprehensive range of switches, sensors, enclosures and operator terminals and suspension systems, we offer our customers effective and versatile solutions. And by conforming to international safety and machine guidelines, our products can be integrated perfectly into individual system solutions.

The evolution of the market is creating new driving forces that is leading to continuous and innovative development. Bernstein meets these changing needs through the provision of superior technical expertise, excellent market knowledge and customer relationships built on trust. Customer Satisfaction is our number one priority. For us, Quality is more than simply making a good product: it's about designing it to perfectly match all your needs.

Your progress is our motivation.

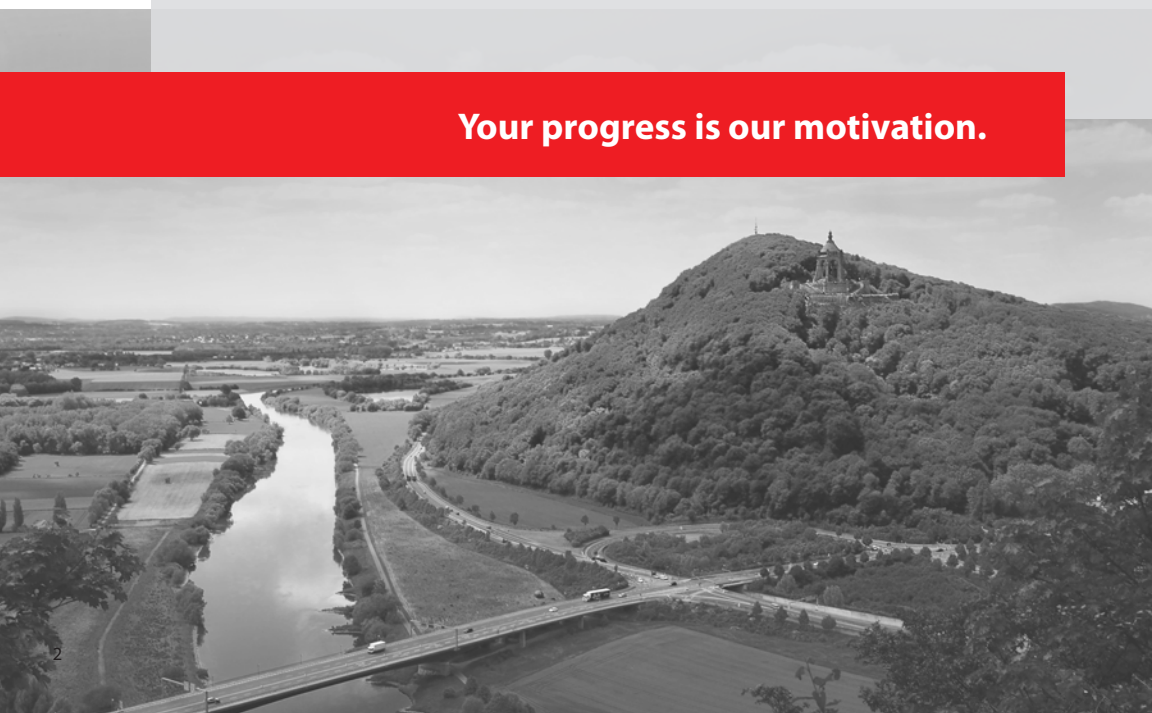



Technically innovative. Personally specific. **Individually special – just like you.**

Customized Solutions are fully integrated into our business and form part of our everyday working life. Employees are treated as our greatest asset as they are responsible for the quality and success of our products. All BERNSTEIN TEAM members are trained and educated to the highest possible standard so that they can deliver “Best in Class” Service and Support. The BERNSTEIN TEAM will always support you both personally and professionally. Working together we will provide you with the best Safe Solution – for any size of project.

Our evergreen enclosure technology

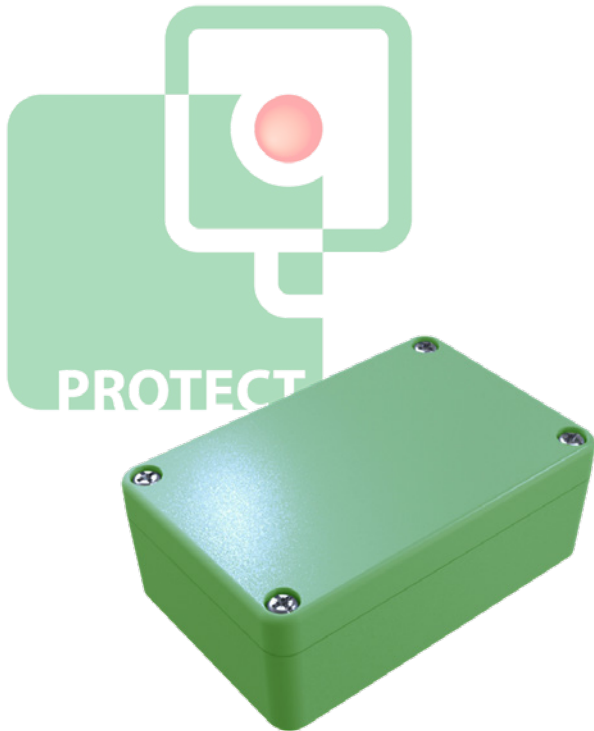

Terminal box, enclosure or connection box? Standard enclosures have many different names and meanings to our customers. Enclosures can contain electrical, electronic, pneumatic, control devices and many other items that require protecting from harsh environments. Whether it be in aluminium, polyester, polycarbonate or ABS, BERNSTEIN has the right solution for you.

Thanks to different materials, the different enclosure types offer economical solutions for every wish, every requirement and every industrial environment.

Personally special. Individually special. Technically innovative.

— as well as the requirements of our customers. These are the strengths of our “Evergreen”.

Including; machining, finishing, pre-assembly of rails, terminals, assembly, to a complete wired solution, BERNSTEIN can satisfy your every need.

Your idea – Our solution.

OUR ADDED VALUE SERVICES

You know BERNSTEIN as a supplier of innovative and reliable enclosure products. But we can offer you even more!

Benefit from the economic advantage of BERNSTEIN: Because we support you with a complete enclosure solution, fully machined, wired, assembled and individually coated.



Customer-specific developments

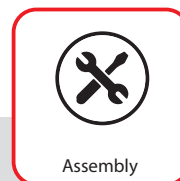

Assembly



Drilling



Coating



Milling



Silkscreen print



Engraving



HF / EMC

Standard enclosures

Customized solutions

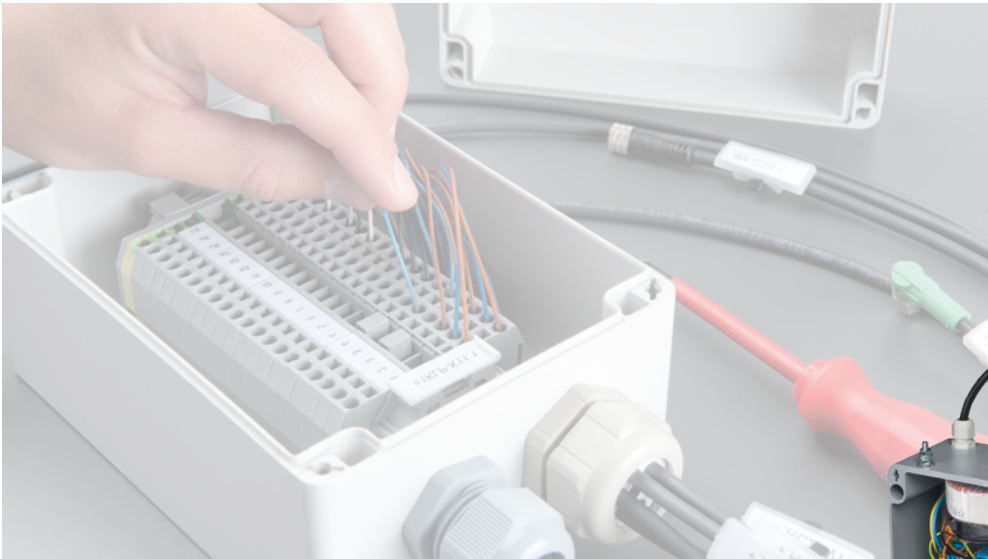

Custom-made wiring and component assembly is directly integrated into our enclosure production facility.

Starting with the pre-assembly of mounting rails and terminals, through to component procurement and complete enclosure assembly, BERNSTEIN can manage this process for you, saving you time and money.

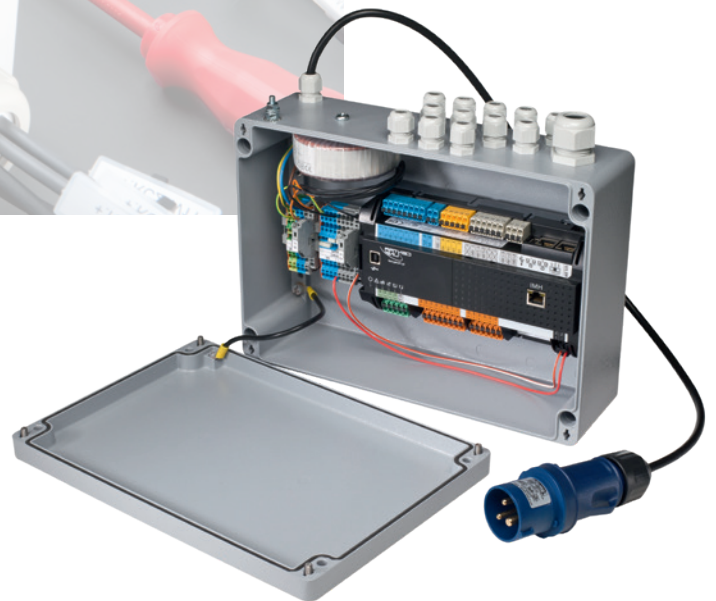

YOUR ADVANTAGES

- Shortened assembly time
- No coordination of external assembly service provider required
- Labour savings thanks to using assembled products from one supplier
- Simplified logistics chain
- Reduced inventory and overheads

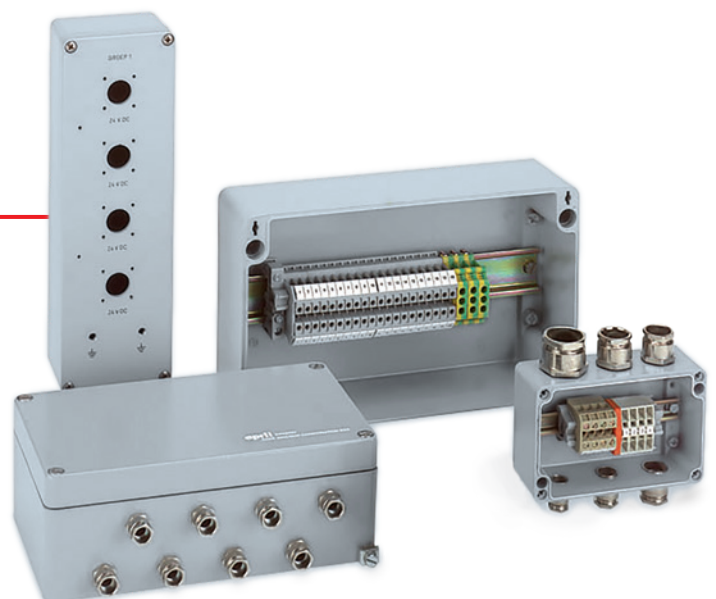

Standard enclosures

Machining examples

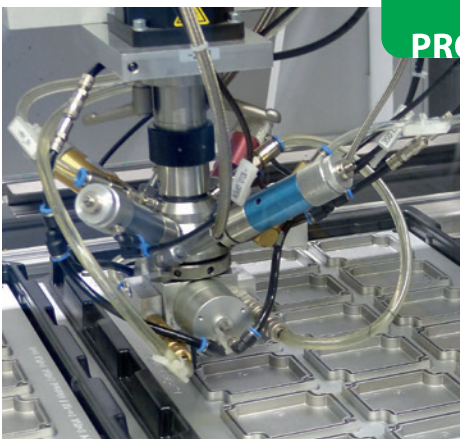
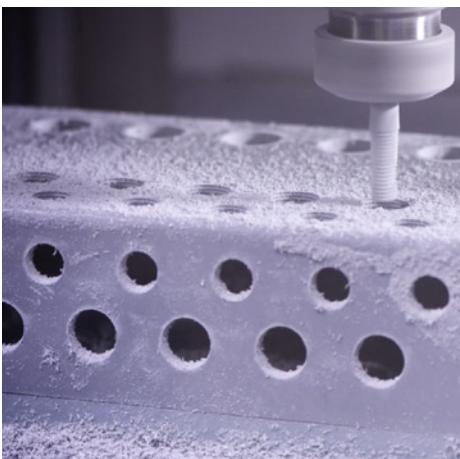

OUR MACHINING SERVICE

As a solutions specialist, BERNSTEIN has core competencies in mechanical engineering. Coupled with an extensive ultra-modern machining and Powder-coating facility, this means that BERNSTEIN can deliver any solution to meet your exacting needs. Whether it's CNC machining, pre-treatment or specialised finishes, we have the right solution for you.

We are not only a solutions provider, we are also the right partner to assist in your design process. With our in-house design team, we can advise on simple things like colours, printing etc., or even assist in the design and production of bespoke enclosure solutions.

BERNSTEIN's customer service offering

- Customisation of standard products according to your wishes
- A finished product from a "one stop" solution

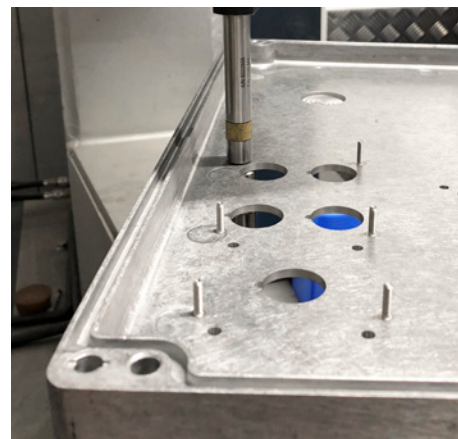

Standard enclosures

Material / type selection

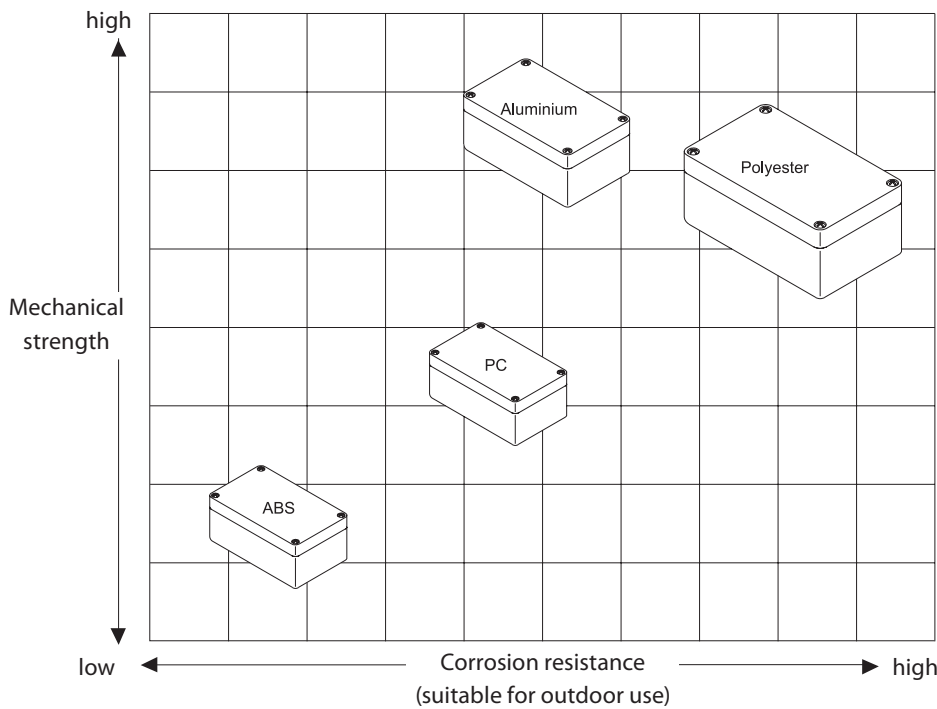

The illustration shows the suitability of different enclosure materials (standard) for mechanical load and corrosion-protecting conditions.



Aluminium **Type CA**



Polycarbonate **Type CT** ABS **Type CT**



Polyester **Type CP**

Material property	Standard	Unit	Aluminium	Polycarbonate	ABS	Polyester
Density	DIN 53479	g/cm ³	2.65	1.2	1.05	1.8
Impact resistance	DIN 53453	mJ/mm ²	150 – 300	65	60	80
Impact strength	DIN 53453	mJ/mm ²	90 – 200	20	10	4
Tensile strength	DIN 53455	N/mm ²	180 – 300	65	43	45
Elongation at break	DIN 53455	%	60 – 90	90	20	20
Modulus of elasticity (bending test)	DIN 53457	N/mm ²	75000	2300	2100	6500
Limiting flexural stress	DIN 53452	N/mm ²		95	90	100
Flammability	UL 94	Classe		V 2	HB	V 0
Volume resistivity	DIN 53482	Ohm x cm		10 ¹⁵	10 ¹³	3 x 10 ¹⁴
Surface resistance	DIN 53482	Ohm x cm		≥ 10 ¹⁵	4 x 10 ¹⁴	> 10 ¹² (black: < 10 ⁹)
Dielectric strength	DIN 53481	kV/mm		25 – 40	24	18 (black: >2kV/cm)
Heat conductivity (20 °C)	DIN 52612	W/mK	120 – 160	0.21	0.18	0.25
Electrical conductivity (20 °C)		m/Ohm mm ²	15 – 22			

Standard enclosures

Assembly

INVENTED BY BERNSTEIN QUICK-RELEASE FASTENER AND FLEXIBLE, INTERNAL ARTICULATED HINGE

- Fixing the cover:
CT (polycarbonate and ABS) standard with quick-release fastener, optionally available for CA (aluminium)
- Time and cost reductions
- Easy to use
- Easy opening and closing (press and turn 90°)
- Easy closure test (recognisable without mechanical test)
- High safety:
The quick-release fastener is under tension and engages.
No opening of the cover in the event of vibrations.
- Easy to assemble
(easy mounting or retrofitting possible due to self-retaining and detent)

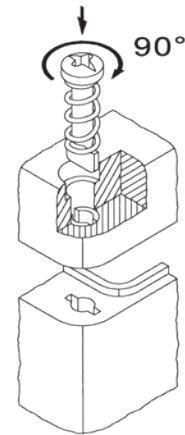
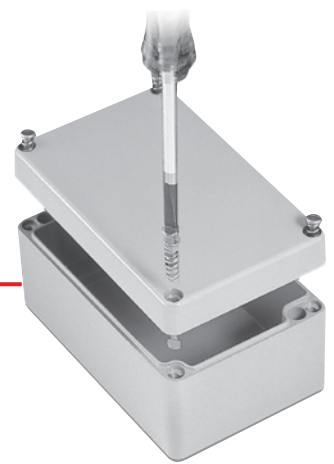

THE QUICK-RELEASE INTERNAL HINGE

The flexible inner joints can be easily mounted in the enclosures without mechanical processing and hold the enclosure cover after opening. This prevents both strain relief and loss of the cover.

For CT
(polycarbonate
and ABS)

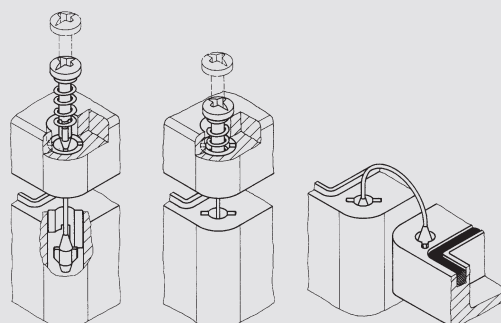

CLOSING THE COVER

- Fixing the cover:
CA (aluminium) and CP (polyester) with screws as standard, optionally available for CT
- The cover screws of the enclosures are made of stainless steel and thanks to the integrated self-retaining system are protected against loss.

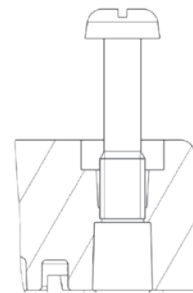
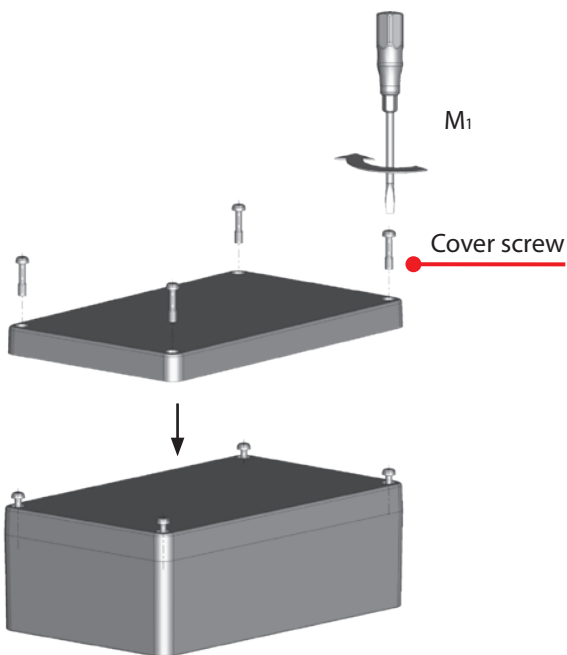

Note, the self-retaining screw must first be turned/screwed through the cover, not pressed in!

SCREW CONNECTION WITH THE BACKGROUND

- Mounting by screw channel



Details to the assembly can be found on www.bernstein.eu/produkte/gehaeuseteknik

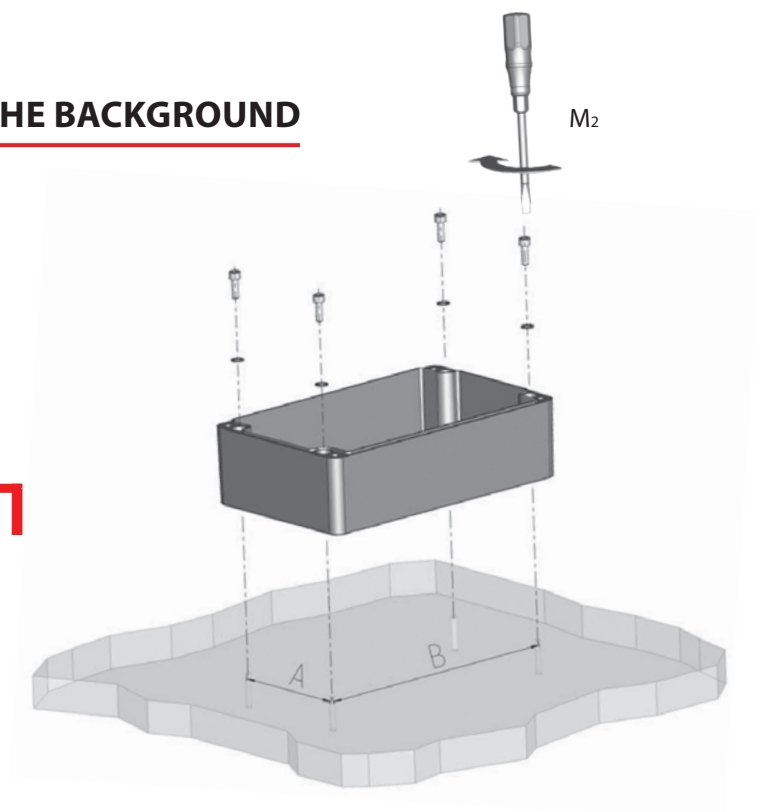

Standard enclosures

Series CA (Aluminium)

CA enclosures from BERNSTEIN are made of aluminium alloys with copper, silicon, iron and manganese. These elements produce various different properties of the enclosure material. For example, by using copper, the strength is increased while silicon promotes corrosion resistance. Iron ensures a higher conductivity, which is a great advantage especially in the electrical sector.

Further positive properties of aluminium alloys are temperature resistance, good thermal conductivity, very good shielding properties and good coating possibilities.

The BERNSTEIN CA series enclosures are manufactured by die casting. As standard, the aluminium enclosures are powder-coated in RAL 7001 in our in-house powder coating plant. However, should a customer make a special request, the colours of the RAL table and powder coatings are available for applications with increased requirements.

BERNSTEIN CA enclosures are supplied with a polyurethane seal in the cover. Alternative seals are available for special applications in high temperature ranges and those involving chemical contact.

There are earthing screws in the cover and lower part to accommodate protective conductors.

The cover screws of the enclosures are made of stainless steel and cannot be lost thanks to a self-locking mechanism integrated in the cover.

The fixing bars or earthing sockets in the enclosure must be used for mounting and fastening built-in components.

Further versions of the BERNSTEIN CA enclosure are, for example, cULus- and Ex-U-certified enclosures.

Exe- and Exi-enclosures with ATEX/IECEx approval are also possible according to customer specifications.



Series CA

Technical data

Standard delivery for the following applications

Specification	Value	according to standard	Note
Materials			
Enclosure	Die-cast aluminium		
Screws	A2		
Seal	PUR (Polyurethane)		Colour: black grey 2K polyurethane foam seal
Powder coating	RAL 7001		silver grey
Protection classes			
IP-Code	IP66/67	DIN EN 60529	
IK-Code	IK08	IEC 62262	
Electrical properties			
Protection class	I	EN 61140 / VDE 0140-1	⚡ Protection by protective conductor
Rated voltage	max. 1000 V (AC) max. 1500 V (DC)		
Chemical properties			
Corrosion resistance	Level A	DIN EN 62208/9.13.2.1	IEC 60068-2-30 and IEC 60068-2-11
Corrosion resistance	Level B	DIN EN 62208/9.13.2.2	IEC 60068-2-30 and IEC 60068-2-11
Toxic behaviour	Halogen free		
Further information			
Product standard	Yes	DIN EN 62208	Empty enclosure for low-voltage switchgear combinations
Conformities			
RoHs	conformal	Directive 2011/65/EU	
CE-label	conformal	EG-No. 765/2008	
Low Voltage Directive No.:	2014/35/EU		
Further versions (the following information is not a standard)			
Approvals			
	see table	UL508A / C22.2	Typ 1, 4, 4x, 12, 13
Enclosure incl. seals			
PUR-seal (standard)	-30°C to +80°C		with standard coating
CR-seal	-30°C to +80°C		with standard coating possible
Silicone foam seal	-60°C to +130°C		without standard coating possible
Silicone full seal	-60°C to +200°C		without standard coating possible
EPDM-seal	-35°C to +100°C		without standard coating possible
HF/EMC-seal	-55°C to +125°C		without standard coating possible

Detailed information on the respective data sheet

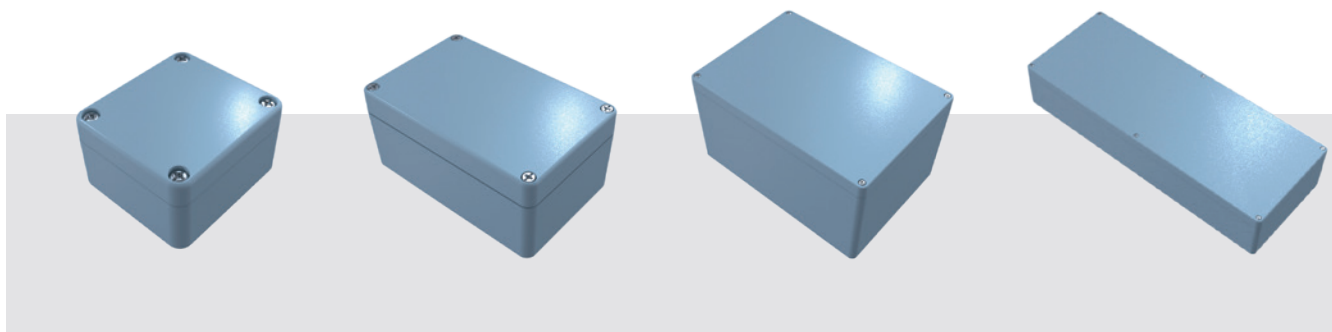

Series CA (Aluminium)

Technical dimensions

Enclosure category / Article number			External dimensions [mm]			approx. wall thicknesses [mm]			Number of cover screws
Standard version			Length	Width	Height incl. cover	Side walls min. dimension	Bottom wall	Cover wall	
CA-020	1020000000	1020004000	50	45	30	2.5	3	2	2
CA-060	1060000000	1060004000	58	64	36	3.5	3.5	3	4
CA-080	1080000000	1080004000	98	64	36	3.5	3.5	3	4
CA-100	1100000000	1100004000	150	64	36	3.5	3.5	3	4
CA-130	1130000000	1130004000	75	80	57	3.5	3.5	2.5	4
CA-140	1140000000	1140004000	75	80	57	3.5	3.5	2.5	4
CA-150	1150000000	1150004000	125	80	57	3.375	3.5	2.6	4
CA-160	1160000000	1160004000	125	80	57	3.375	3.5	2.6	4
CA-170	1170000000	1170004000	175	80	57	3.5	3.5	2.5	4
CA-180	1180000000	1180004000	175	80	57	3.5	3.5	2.5	4
CA-190	1190000000	1190004000	250	80	57	3.5	3.5	2.5	4
CA-210	1210000000	1210004000	122	122	80	4.4	4.1	3.7	4
CA-215	1210000050	1210004050	122	122	90	4.4	4.1	4	4
CA-220	1220000000	1220004000	122	122	80	4.4	4.1	3.7	4
CA-230	1230000000	1230004000	220	122	80	4.5	4	4	4
CA-235	1230000050	1230004050	220	122	90	4.5	4	4	4
CA-240	1240000000	1240004000	220	122	80	4.5	4	4	4
CA-250	1250000000	1250004000	360	122	80	4.4	4.1	3.7	4
CA-270	1270000000	1270004000	160	160	90	4.15	4.1	3.7	4
CA-280	1280000000	1280004000	160	160	90	4.15	4.1	3.7	4
CA-290	1290000000	1290004000	260	160	90	4.25	4	4	4
CA-300	1300000000	1300004000	260	160	90	4.25	4	4	4
CA-310	1310000000	1310004000	360	160	90	4.15	4.1	3.7	4
CA-330	1330000000	1330004000	560	160	90	4.1	4	4	6
CA-350	1350000000	1350004000	200	230	110	4.4	4.1	4.1	4
CA-360	1360000000	1360004000	200	230	180	4.4	4.5	3.7	4
CA-370	1370000000	1370004000	280	230	110	4.4	4.1	3.7	4
CA-380	1380000000	1380004000	330	230	110	4.4	4.1	3.7	4
CA-390	1390000000	1390004000	330	230	180	4.4	4.5	3.7	4
CA-400	1400000000	1400004000	400	230	110	4.4	4.1	3.7	4
CA-420	1420000000	1420004000	600	230	110	3.7	4	4	6
CA-450	1450000000	1450004000	402.5	310	110	5.1	5.4	3.7	4
CA-460	1460000000	1460004000	402.5	310	180	5.1	5.4	3.7	4
CA-470	1470000000	1470004000	600	310	110	5.5	6	4	6
CA-480	1480000000	1480004000	600	310	180	5.5	4	4	6

Series CA

Technical drawings

Top view

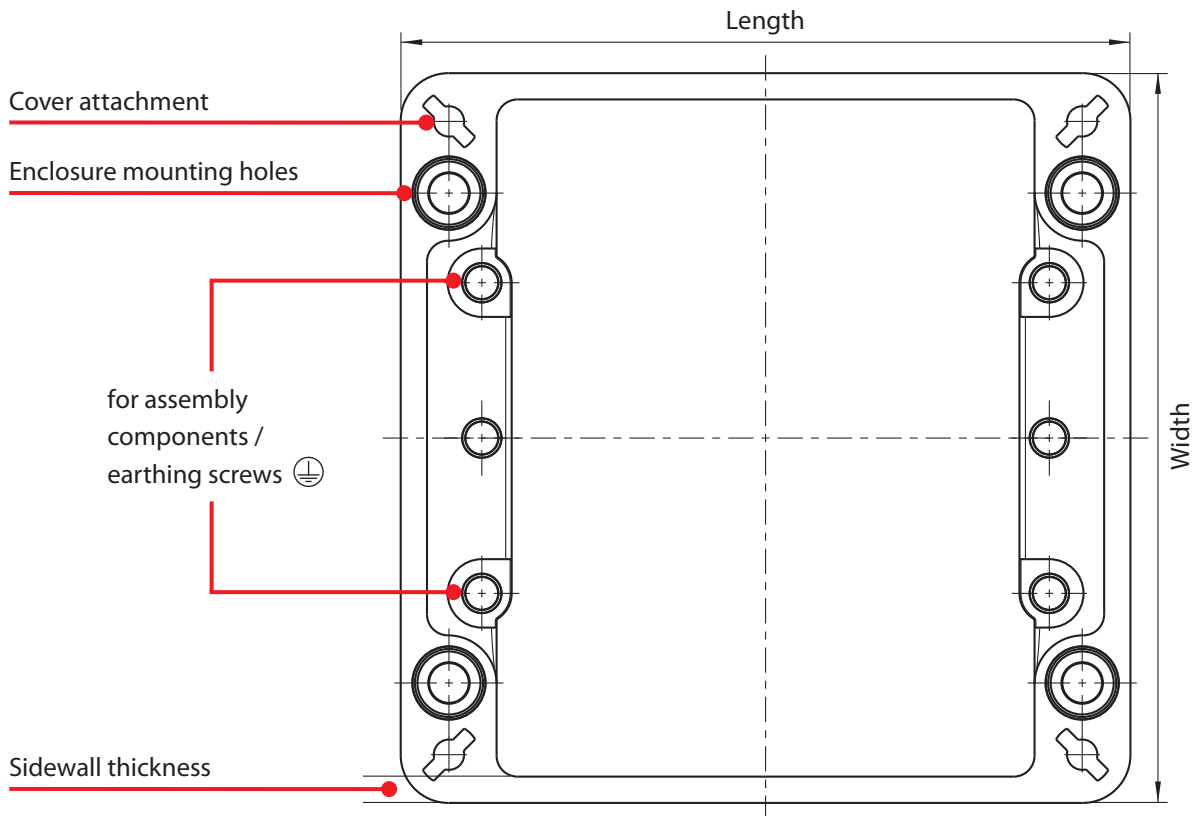

Side view

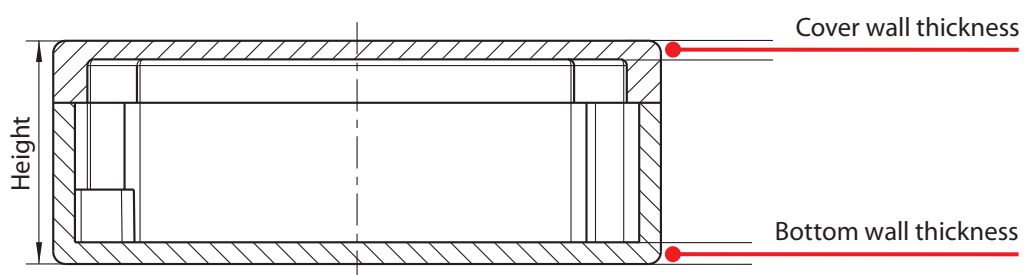

Detailed drawings of the individual enclosures can be found
at www.bernstein.eu/produkte/gehaeuseteknik

Standard enclosures

Series CT (Polycarbonate and ABS)

The BERNSTEIN CT series enclosures are made of ABS and polycarbonate (PC), are thermoplastics and are manufactured by injection moulding. The plastic ABS is characterized by low weight, high impact strength, scratch resistance, chemical resistance and good insulation properties. Polycarbonate has higher strength, stiffness than ABS and good insulating properties. The enclosures of the CT series are particularly suitable for encapsulating electrical and electronic components as well as complete small controllers. All enclosures are also available with a transparent polycarbonate cover. As standard, the enclosures are supplied with a PUR seal in the cover to ensure compliance with the degree of protection.

The plastic enclosures at the bottom of the lower parts are equipped with fastening cams for fastening built-in components. With the enclosed self-tapping fixing screws, fixtures can be attached easily and flexibly.

As standard, the BERNSTEIN CT series enclosures are supplied with the quick-release fastener developed and patented by BERNSTEIN. The enclosed quick-release fastener can be simply pressed into the cover and it then holds itself in place. It is made of stainless steel.

BERNSTEIN plastic enclosures made of polycarbonate and ABS are manufactured in RAL 7035 (light grey) as standard. It is, of course, possible to colour the enclosures to customer specifications in the colours of the RAL table.



The polycarbonate enclosures from BERNSTEIN can be ordered in a cULus version.



Series CT

Technical data

Standard delivery for the following applications

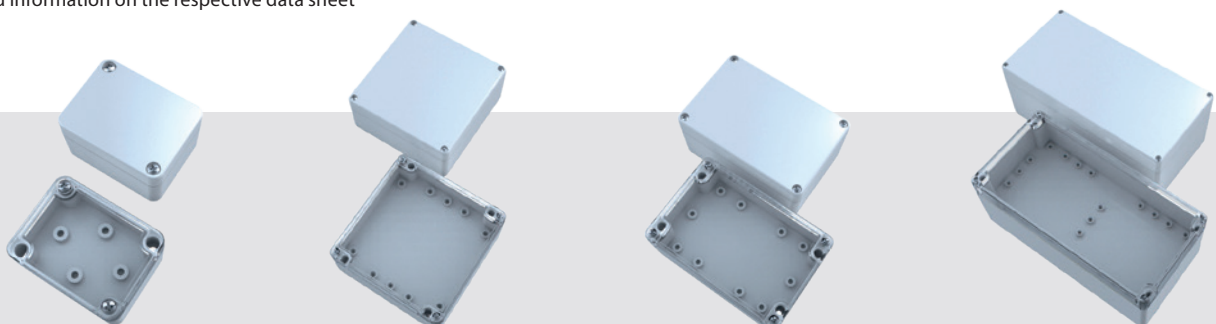

Specification	Value Polycarbonate	Value ABS	according to standard	Note
Materials				
Enclosure	Polycarbonate (PC)	ABS		similar to RAL 7035 light grey (optional transparent cover)
Quick-release fastener	A2	A2		
Seal	PUR (Polyurethane)	PUR (Polyurethane)		2K polyurethane foam seal CT 50/52 = EPDM-seal
Protection classes				
IP-Code	IP65	IP65	DIN EN 60529	CT 50/52
	IP66	IP66	DIN EN 60529	CT 54-91
IK-Code	IK06	IK06	IEC 62262	CT 50/52
	IK07	IK07	IEC 62262	CT 54-91
Electrical properties				
Protection class	II	II	EN 61140 / VDE 0140-1	 Protection by double or reinforced insulation
Rated voltage	max. 1000 V (AC)	max. 1000 V (AC)		maximum layout
Surface resistance	10 ¹⁵ Ohm	10 ¹³ Ohm	IEC 60093	transparent cover (PC) = 10 ¹⁶ Ohm
Dielectric strength	33 kV/mm	17 kV/mm	IEC 60243-1	transparent cover (PC) = 25 kV/mm
Chemical properties				
Toxic behaviour	Halogen free	Halogen free		
Thermal properties				
Flammability	V-2	HB	UL 94	Similar in content to EC60695-11-10 and EC60695-11-20
Glow wire test	960°C; 2 mm	650°C	IEC 60695-2-12	transparent cover (PC) = 850°C; 1-2 mm
Glow wire test	960°C; 1 mm	675°C	IEC 60695-2-12	transparent cover (PC) = 800°C; 3 mm
Further information				
Product standard	Yes	Yes	DIN EN 62208	Empty enclosure for low-voltage switchgear combinations
Conformities				
RoHs	conformal	conformal	Directive 2011/65/EU	
CE-Label	conformal	conformal	EG-No. 765/2008	
Low Voltage Directive No.:	2014/35/EU	2014/35/EU		
Further versions (the following information is not standard)				
Approvals				
	see table	—	UL508A / C22.2	Typ 1, 4, 4x indoor
Enclosure incl. seals				
PUR-Seal (Standard)	-40°C to +100°C	-40°C to +80°C		
CR-seal	-30°C to +80°C	-30°C to +80°C		
Silicone foam seal	-40°C to +100°C	-40°C to +80°C		
Silicone full seal	-40°C to +100°C	-40°C to +80°C		
EPDM-seal	-35°C to +100°C	-35°C to +80°C		
HF/EMC-seal	-40°C to +100°C	-40°C to +80°C		

Detailed information on the respective data sheet



Series CT (Polycarbonate and ABS)

Technical dimensions

Enclosure category / Article number					External dimensions [mm]			approx. wall thicknesses [mm]			Number of cover screws
PC	PC + transp. cover PC	 PC	 PC + transp. cover PC	Length	Width	Height incl. cover	Side walls min. dimension	Bottom wall	Cover wall		
CT-501	2500000000	2501000000	2500004000	2501004000	52	50	35	2,5	2,25	2,25	2
CT-521	2520000000	2521000000	2520004000	2521004000	65	50	35	2,6	2,25	2,25	2
CT-541	2540000000	2541000000	2540004000	2541004000	82	80	55	3	3,5	3,5	4
CT-561	2560000000	2561000000	2560004000	2561004000	82	80	85	3	2,5	3,5	4
CT-581	2580000000	2581000000	2580004000	2581004000	120	80	55	3	3,5	3,5	4
CT-601	2600000000	2601000000	2600004000	2601004000	120	80	85	3	3,5	3,5	4
CT-621	2620000000	2621000000	2620004000	2621004000	160	80	55	3,1	3	3,5	4
CT-641	2640000000	2641000000	2640004000	2641004000	160	80	85	3,05	3	3,5	4
CT-661	2660000000	2661000000	2660004000	2661004000	122	120	55	3	3,5	3,5	4
CT-681	2680000000	2681000000	2680004000	2681004000	122	120	85	3	3,5	3,5	4
CT-721	2720000000	2721000000	2720004000	2721004000	160	120	90	3	3	2,5	4
CT-761	2760000000	2761000000	2760004000	2761004000	200	120	75	3	3,5	3,5	4
CT-781	2780000000	2781000000	2780004000	2781004000	200	120	90	3	3,5	2,5	4
CT-801	2800000000	2801000000	2800004000	2801004000	240	120	100	3	3,5	3,5	4
CT-821	2820000000	2821000000	2820004000	2821004000	200	150	75	3	3,5	3,5	4
CT-841	2840000000	2841000000	2840004000	2841004000	240	160	90	3,1	3,5	3,5	6
CT-861	2860000000	2861000000	2860004000	2861004000	240	160	120	3,1	3,5	3,5	6
CT-871	2870000000	2871000000	2870004000	2871004000	300	230	86	3	3	3	6
CT-881	2880000000	2881000000	2880004000	2881004000	360	200	150	4	3,5	3,5	6
CT-891	2890000000	2891000000	2890004000	2891004000	300	230	110	3	3	3	6
CT-901	2900000000	2901000000	2900004000	2901004000	250	160	90	3,1	3,5	3,5	6
CT-911	2910000000	2911000000	2910004000	2911004000	250	160	120	3,1	3,5	3,5	6

Enclosure category / Article number		External dimensions [mm]			approx. wall thicknesses [mm]			Number of cover screws	
ABS	ABS + transp. cover PC	Length	Width	Height incl. cover	Side walls min. dimension	Bottom wall	Cover wall		
CT-502	3500000000	3501000000	52	50	35	2,5	2,25	2,25	2
CT-522	3520000000	3521000000	65	50	35	2,6	2,25	2,25	2
CT-542	3540000000	3541000000	82	80	55	3	3,5	3,5	4
CT-562	3560000000	3561000000	82	80	85	3	2,5	3,5	4
CT-582	3580000000	3581000000	120	80	55	3	3,5	3,5	4
CT-602	3600000000	3601000000	120	80	85	3	3,5	3,5	4
CT-622	3620000000	3621000000	160	80	55	3,1	3	3,5	4
CT-642	3640000000	3641000000	160	80	85	3,05	3	3,5	4
CT-662	3660000000	3661000000	122	120	55	3	3,5	3,5	4
CT-682	3680000000	3681000000	122	120	85	3	3,5	3,5	4
CT-722	3720000000	3721000000	160	120	90	3	3	2,5	4
CT-762	3760000000	3761000000	200	120	75	3	3,5	3,5	4
CT-782	3780000000	3781000000	200	120	90	3	3,5	2,5	4
CT-802	3800000000	3801000000	240	120	100	3	3,5	3,5	4
CT-822	3820000000	3821000000	200	150	75	3	3,5	3,5	4
CT-842	3840000000	3841000000	240	160	90	3,1	3,5	3,5	6
CT-862	3860000000	3861000000	240	160	120	3,1	3,5	3,5	6
CT-872	3870000000	3871000000	300	230	86	3	3	3	6
CT-882	3880000000	3881000000	360	200	150	4	3,5	3,5	6
CT-892	3890000000	3891000000	300	230	110	3	3	3	6
CT-902	3900000000	3901000000	250	160	90	3,1	3,5	3,5	6
CT-912	3910000000	3911000000	250	160	120	3,1	3,5	3,5	6

Series CT

Technical drawings

Top view

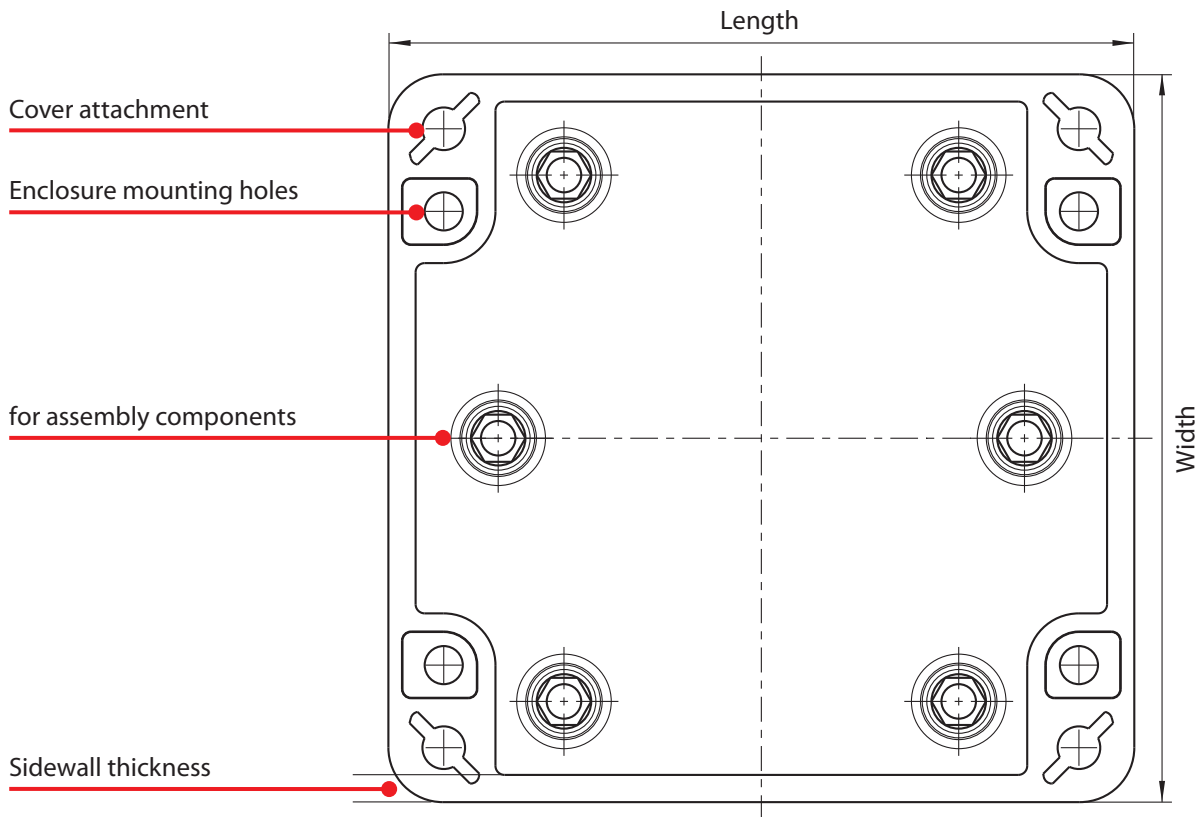

Side view

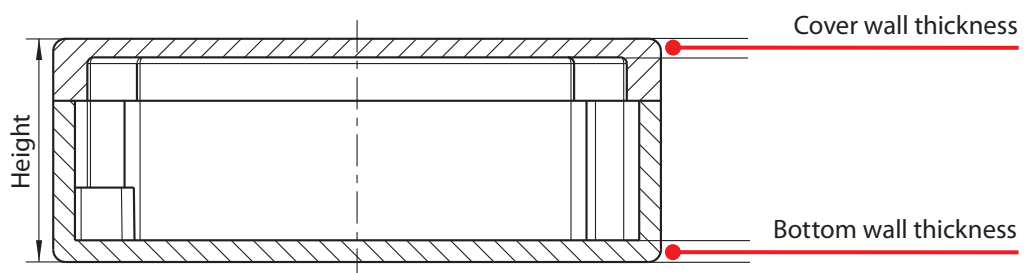

Detailed drawings of the individual enclosures can be found at www.bernstein.eu/produkte/gehaeuseteknik

Standard enclosures

Series CP (Polyester)

The CP series group of plastic enclosures consists of unsaturated polyester resins with glass fibre reinforcement. These are processed by pressing. Unsaturated polyester resins with glass fibre reinforcement have a mechanical strength in the range of unalloyed steels. In addition, the typical shrinkage and creep tendency of plastics is reduced by the glass fibres. Polyester resins have good electrical properties and good dielectric behaviour.

Polyester enclosures are therefore particularly suitable for accommodating and encapsulating electrical and electronic components and control components in harsh environmental conditions or hazardous areas.

As standard, the CP enclosures are supplied with a PUR seal fitted in the cover. For applications in technically demanding areas with temperature changes and chemical contact, BERNSTEIN also offers CP enclosures with alternative sealing materials.

The inserted cover screws are made of stainless steel and can not be lost thanks to a self-locking mechanism integrated in the cover.

Depending on their size, BERNSTEIN polyester enclosures have mounting options in M4 or M6 in the lower part. The mounting sockets are pressed into a web on the narrow sides inside the base and are used to accommodate mounting plates, mounting rails, printed circuit boards, etc.

The polyester enclosures are available in grey (RAL 7001, silver grey) or black (RAL 9005, deep black) as standard. For larger quantities, it is possible to colour or coat the plastic enclosures according to the customer's requirements.

The enclosures of the CP series are also available as cULus and EX-U versions.

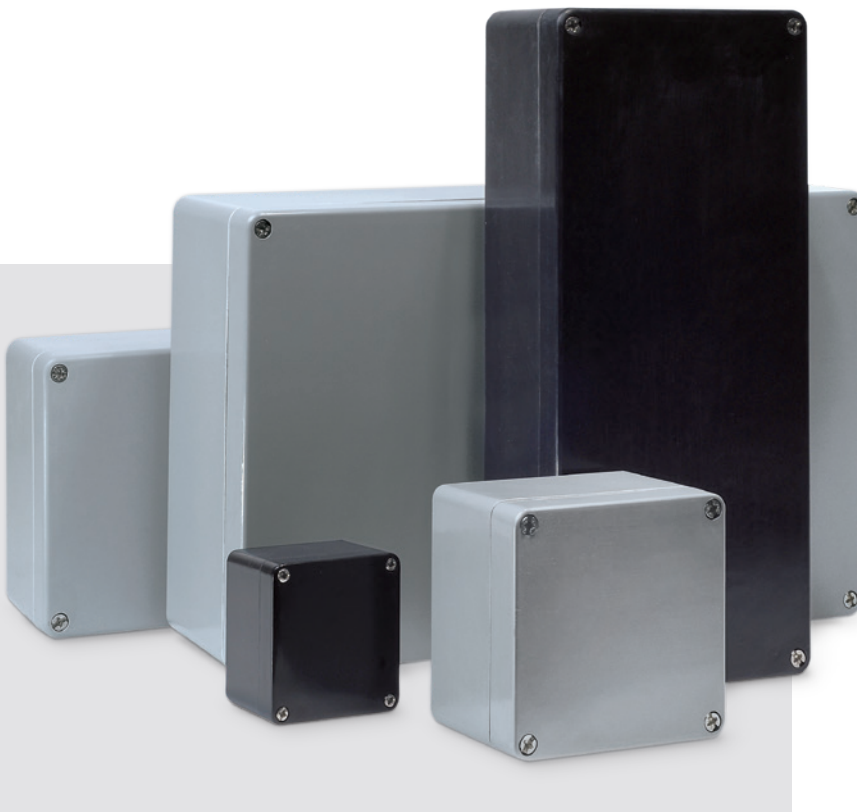

Exe- and Exi enclosures with ATEX/IECEX approval are also possible according to customer specifications.



Series CP

Technical data

Standard delivery for the following applications

Specification	Value CPG (grey)	Value CPS (black)	according to standard	Note
Materials				
Enclosure	Polyester (SMC 0190)	Polyester (SMC 2600)		
Screw	A2	A2		
Seal	PUR (Polyurethane)	PUR (Polyurethane)	DIN EN ISO 3506-1	2K polyurethane foam seal
Protection classes				
IP-Code	IP66/67	IP66/67	DIN EN 60529	
IK-Code	IK08	IK08	IEC 62262	
Electrical properties				
Protection class	II	–	EN 61140 / VDE 0140-1	 Protection by double or reinforced insulation
Rated voltage	max. 750 V	max. 500 V		maximum layout
Surface resistance	10 ¹² Ohm	<10 ⁹ Ohm	IEC 60093	
Dielectric strength	18 kV/mm	>2 kV/cm	IEC 60243-1	
Chemical properties				
Toxic behaviour	Halogen free	Halogen free		
Thermal properties				
Flammability	V-0	V-0	UL 94	Similar in content to EC60695-11-10 and IEC60695-11-20
Glow wire test	960°C	960°C; 3.2 mm	IEC 60707-3	
Further information				
Product standard	yes	yes	DIN EN 62208	Empty enclosure for low-voltage switchgear combinations
Conformities				
RoHs	conformal	conformal	Directive 2011/65/EU	
CE-Label	conformal	conformal	EG-No. 765/2008	
Low Voltage Directive No.:	2014/35/EU	2014/35/EU		
Further versions (the following information is not standard)				
Approvals				
	see table	see table	UL508A / C22.2	Typ 1, 4, 4x
Enclosure incl. seals				
PUR-seal (Standard)	-40°C to +100°C	-40°C to +100°C		Enclosure material -40°C to +165°C
CR-seal	-30°C to +80°C	-30°C to +80°C		
Silicone foam seal	-40°C to +130°C	-40°C to +130°C		
Silicone full seal	-40°C to +165°C	-40°C to +165°C		
EPDM-seal	-35°C to +100°C	-35°C to +100°C		
HF/EMC-seal	-40°C to +125°C	-40°C to +125°C		

Detailed information on the respective data sheet

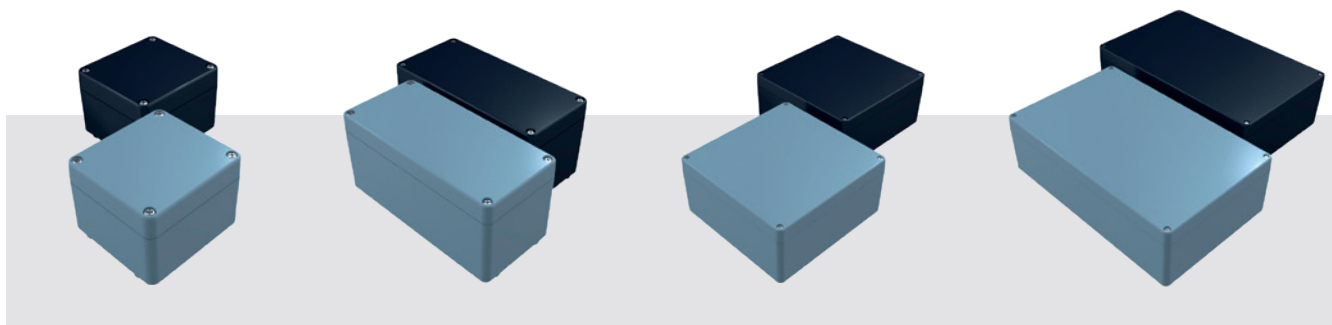

Series CP (Polyester)

Technical dimensions

CPG (grey)	Enclosure category / Article number		External dimensions [mm]			approx. wall thicknesses [mm]			Number of cover screws
Standard version			Length	Width	Height incl. cover	Side walls min. dimension	Bottom wall	Cover wall	
CPG-140	4140000000	4140004000	80	75	55	4.25	3.5	4	4
CPG-145	4140000050	4140004050	80	75	75	4.25	3.5	4	4
CPG-150	4150000000	4150004000	110	75	55	4.25	3.5	4	4
CPG-155	4150000050	4150004050	110	75	75	4.25	3.5	4	4
CPG-170	4170000000	4170004000	160	75	55	4.25	3.5	4	4
CPG-175	4170000050	4170004050	160	75	75	4.25	3.5	4	4
CPG-190	4190000000	4190004000	190	75	55	4.25	3.5	4	4
CPG-195	4190000050	4190004050	190	75	75	4.25	3.5	4	4
CPG-220	4220000000	4220004000	122	120	90.5	4.5	4.5	5	4
CPG-240	4240000000	4240004000	220	120	90.5	4.5	4.5	4	4
CPG-280	4280000000	4280004000	160	160	91	6	6	5	4
CPG-300	4300000000	4300004000	260	160	91	6	6	5	4
CPG-320	4320000000	4320004000	360	160	91	6	6	5	4
CPG-330	4330000000	4330004000	560	160	91	6	6	5	6
CPG-370	4370000000	4370004000	255	250	120	5.75	6	5	4
CPG-400	4400000000	4400004000	400	250	120	5.75	6	5	4
CPG-450	4450000000	4450004000	400	405	120	5.75	6	5	4
CPG-460	4460000000	4460004000	400	405	165	5.75	6	5	4

CPS (black)	Enclosure category / Article number		External dimensions [mm]			approx. wall thicknesses [mm]			Number of cover screws
			Length	Width	Height incl. cover	Side walls min. dimension	Bottom wall	Cover wall	
CPS-140	5140000000	5140004000	80	75	55	4.25	3.5	4	4
CPS-145	5140000050	5140004050	80	75	75	4.25	3.5	4	4
CPS-150	5150000000	5150004000	110	75	55	4.25	3.5	4	4
CPS-155	5150000050	5150004050	110	75	75	4.25	3.5	4	4
CPS-170	5170000000	5170004000	160	75	55	4.25	3.5	4	4
CPS-175	5170000050	5170004050	160	75	75	4.25	3.5	4	4
CPS-190	5190000000	5190004000	190	75	55	4.25	3.5	4	4
CPS-195	5190000050	5190004050	190	75	75	4.25	3.5	4	4
CPS-220	5220000000	5220004000	122	120	90.5	4.5	4.5	5	4
CPS-240	5240000000	5240004000	220	120	90.5	4.5	4.5	4	4
CPS-280	5280000000	5280004000	160	160	91	6	6	5	4
CPS-300	5300000000	5300004000	260	160	91	6	6	5	4
CPS-320	5320000000	5320004000	360	160	91	6	6	5	4
CPS-330	5330000000	5330004000	560	160	91	6	6	5	6
CPS-370	5370000000	5370004000	255	250	120	5.75	6	5	4
CPS-400	5400000000	5400004000	400	250	120	5.75	6	5	4
CPS-450	5450000000	5450004000	400	405	120	5.75	6	5	4
CPS-460	5460000000	5460004000	400	405	165	5.75	6	5	4

Series CP

Technical drawings

Top view

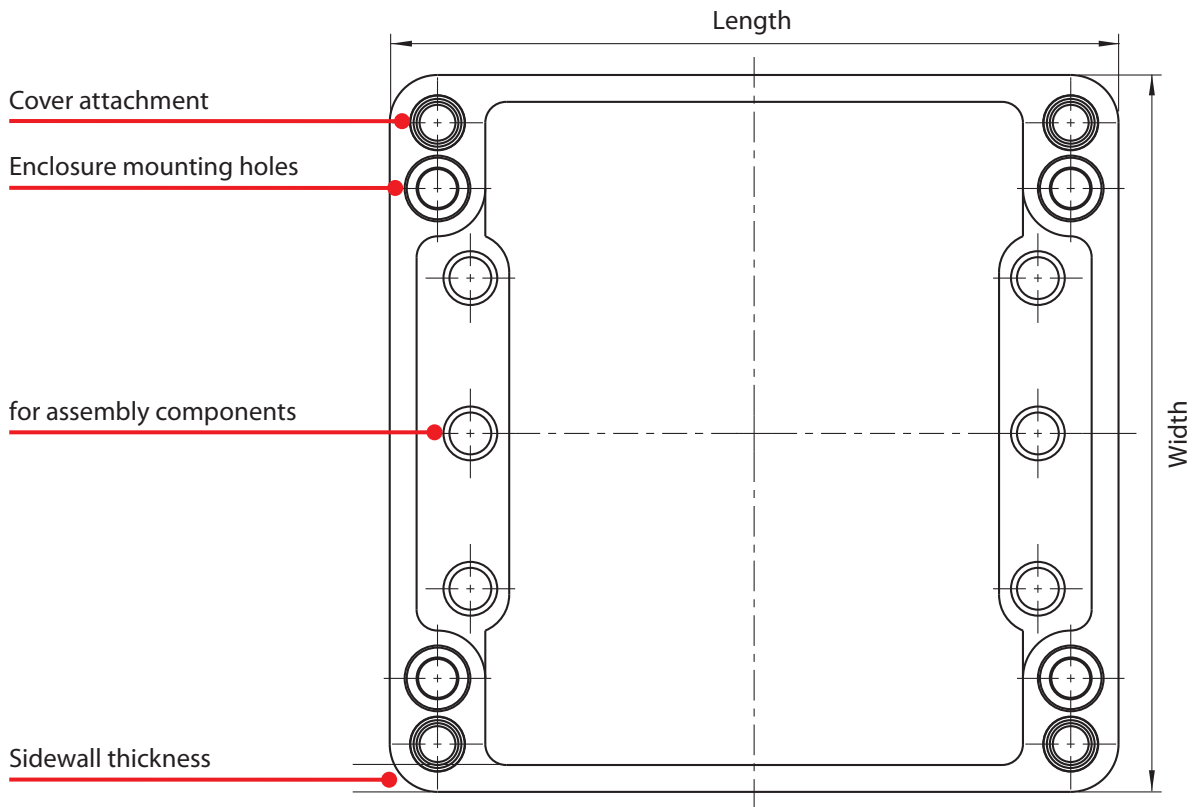

Side view

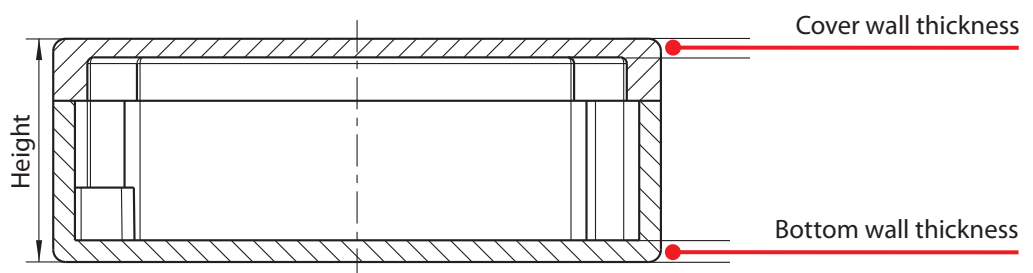

Detailed drawings of the individual enclosures can be found
at www.bernstein.eu/produkte/gehaeuseteknik

Standard enclosures

Manufacturing standards

Technical information on enclosure machining

As an ISO-9001-2008-certified company, BERNSTEIN has defined a manufacturing standard that applies to the processing orders it receives if there are no further agreements.

Dimension tolerances

- When preparing details for enclosure machining (see the following drawings, showing the enclosure orientation when set up for machining), the tolerances used for the first machining operation on each set up, are according to ISO 2768-mH
- Tolerances between further machining operations can be limited to ± 0.1 mm compared to each other

General tolerances for unmachined parts – Standard range

Material / Enclosure type	General tolerance
CA-020 to CA-480 Cast aluminium	DIN 1688 GTA 13/5
CT-50 to CT-91 PC/ABS	DIN 16901
CP-140 to CP-460 Polyester-mats	DIN 16901

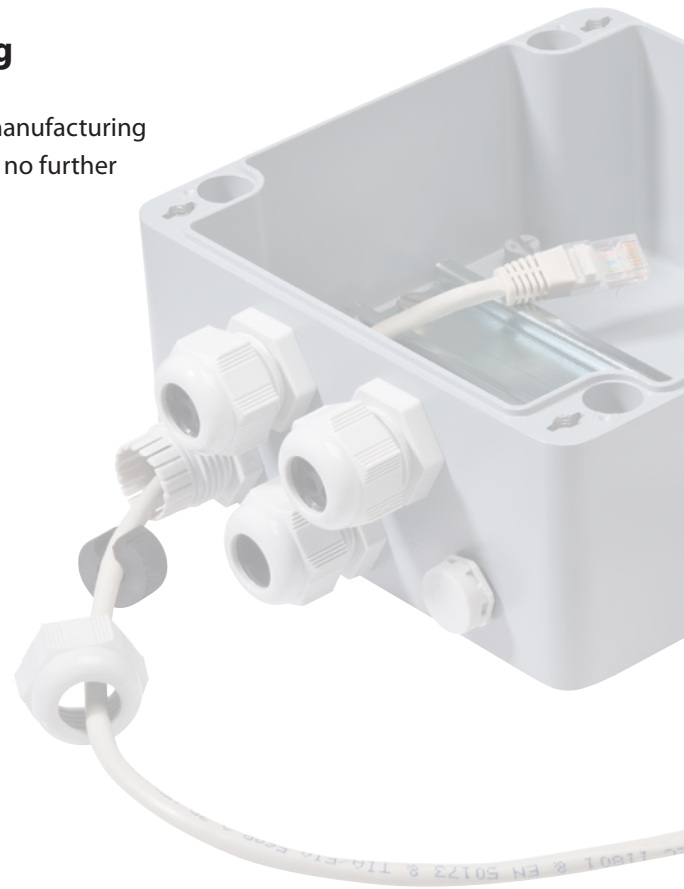

Minimum purchase quantities

In order to keep enclosure machining as cost-effective for the user as possible, the following minimum purchase quantities are suggested:

Description	Quantity
CA-020 ... CA-080	20 pieces
CA-100 ... CA-190	10 pieces
CA-210 ... CA-310	10 pieces
CA-330 ... CA-480	5 pieces
CP-140 ... CP-195	20 pieces
CP-220 ... CP-320	10 pieces
CP-330 ... CP-460	5 pieces
CT-50 ... CT-76	20 pieces
CT-78 ... CT-89	10 pieces

These quantities should be regarded as the minimum, if the customised enclosures are to be produced economically. Production includes mechanical machining, special coating, screen-printing, engraving or assembly of accessories. Of course, BERNSTEIN would always be pleased to advise you.

Standard enclosures

Contact surfaces for machine processing

Machining at right angles to the machining surface

Type series

CA-020 to CA-240 und CA-270 to CA-300
CT-50 to CT-82, CP-140 to CP-300

Type series

CA-250 and CA-310 to CA-480
CT-84 to CT-91, CP-320 to CP-460

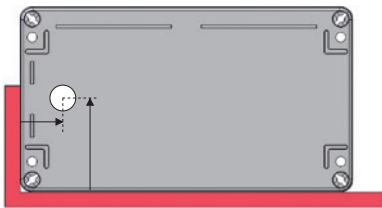

Bottom part
Treatment of the floor area
Side E

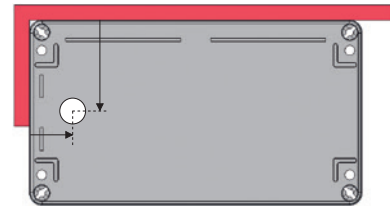

Bottom part
Treatment of the floor area
Side E

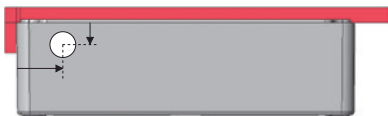

Bottom part
Lateral machining
Side A, B, C, D

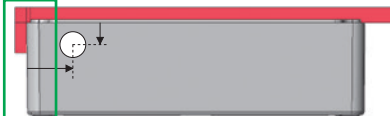
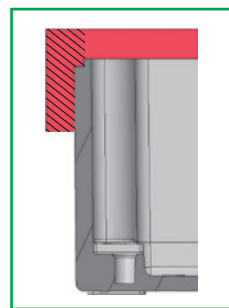

Bottom part
Lateral machining
Side A, B, C, D

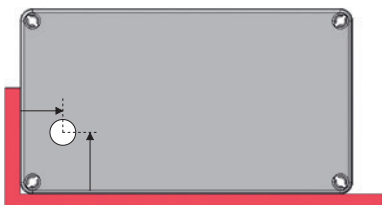

Cover
Machining of the cover surface
Side F

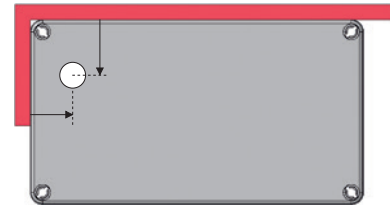

Cover
Machining of the cover surface
Side F

SIDES

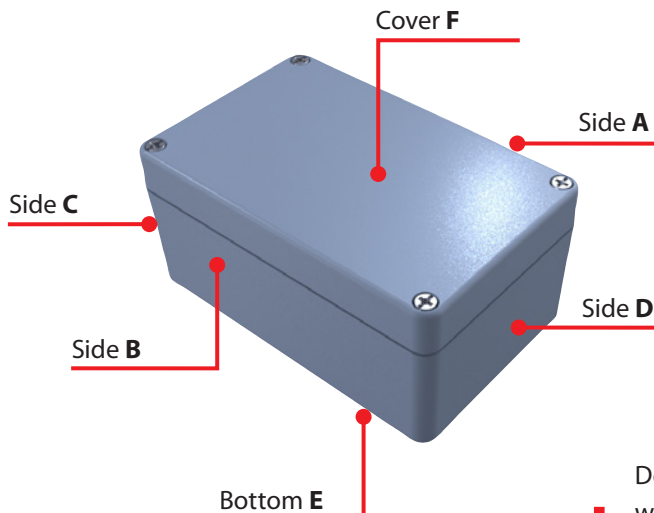

Details of the individual enclosures can be found at www.bernstein.eu/produkte/gehauseteknik

Series CA

Max. number of threaded holes

Type	ISO M	M12	M16	M20	M25	M32	M40	M50	M63
CA-020	Side A/B	1	0	0	0	0	0	0	0
	Side C/D	1	0	0	0	0	0	0	0
CA-060	Side A/B	2	1	0	0	0	0	0	0
	Side C/D	1	0	0	0	0	0	0	0
CA-080	Side A/B	4	3	0	0	0	0	0	0
	Side C/D	1	0	0	0	0	0	0	0
CA-100	Side A/B	6	4	0	0	0	0	0	0
	Side C/D	1	0	0	0	0	0	0	0
CA-130	Side A/B	5	2	1	0	0	0	0	0
	Side C/D	3	2	1	0	0	0	0	0
CA-140	Side A/B	5	2	1	1	0	0	0	0
	Side C/D	3	2	1	1	0	0	0	0
CA-150	Side A/B	10	4	3	2	0	0	0	0
	Side C/D	3	2	1	0	0	0	0	0
CA-160	Side A/B	10	4	3	2	0	0	0	0
	Side C/D	4	2	1	1	0	0	0	0
CA-170	Side A/B	14	6	4	4	0	0	0	0
	Side C/D	3	2	1	0	0	0	0	0
CA-180	Side A/B	14	6	4	4	0	0	0	0
	Side C/D	4	2	1	1	0	0	0	0
CA-190	Side A/B	22	9	7	5	0	0	0	0
	Side C/D	3	2	1	0	0	0	0	0
CA-210	Side A/B	12	6	4	2	2	0	0	0
	Side C/D	5	2	2	1	0	0	0	0
CA-215	Side A/B	12	6	4	2	2	0	0	0
	Side C/D	5	2	2	1	0	0	0	0
CA-220	Side A/B	12	6	4	2	2	0	0	0
	Side C/D	5	2	2	1	0	0	0	0
CA-230	Side A/B	27	12	8	5	4	0	0	0
	Side C/D	5	2	2	1	0	0	0	0
CA-235	Side A/B	27	12	8	5	4	0	0	0
	Side C/D	5	2	2	1	0	0	0	0
CA-240	Side A/B	27	12	8	5	4	0	0	0
	Side C/D	5	2	2	1	0	0	0	0
CA-250	Side A/B	48	21	16	9	6	0	0	0
	Side C/D	5	2	2	1	0	0	0	0
CA-270	Side A/B	20	9	6	4	2	2	1	0
	Side C/D	8	4	3	2	2	0	0	0
CA-280	Side A/B	20	9	6	4	2	2	1	0
	Side C/D	8	4	3	2	2	0	0	0
CA-290	Side A/B	36	17	12	7	4	3	3	0
	Side C/D	8	4	3	2	2	0	0	0
CA-300	Side A/B	36	17	12	7	4	3	3	0
	Side C/D	8	4	3	2	2	0	0	0
CA-310	Side A/B	54	26	18	11	6	5	4	0
	Side C/D	8	4	3	2	2	0	0	0
CA-330	Side A/B	84	40	28	16	10	8	6	0
	Side C/D	8	4	3	2	2	0	0	0
CA-350	Side A/B	35	15	12	8	4	3	2	2
	Side C/D	26	12	8	5	3	2	2	1
CA-360	Side A/B	56	32	20	13	9	5	4	4
	Side C/D	52	27	18	12	8	5	3	3

Type	ISO M	M12	M16	M20	M25	M32	M40	M50	M63
CA-370	Side A/B	53	25	18	11	7	4	3	3
	Side C/D	26	12	8	5	3	2	2	1
CA-380	Side A/B	65	30	23	12	9	5	4	3
	Side C/D	24	12	8	5	3	2	2	1
CA-390	Side A/B	108	54	40	25	15	9	8	6
	Side C/D	52	27	18	12	8	5	3	3
CA-400	Side A/B	80	38	27	17	11	6	5	4
	Side C/D	26	12	8	5	3	2	2	1
CA-420	Side A/B	120	56	42	24	16	8	8	6
	Side C/D	28	13	8	5	3	2	2	1
CA-450	Side A/B	80	38	27	17	11	6	5	4
	Side C/D	38	21	13	7	5	4	3	2
CA-460	Side A/B	136	68	50	30	21	12	10	8
	Side C/D	74	38	28	18	12	8	6	3
CA-470	Side A/B	120	56	42	24	16	8	8	6
	Side C/D	38	17	13	7	5	4	3	2
CA-480	Side A/B	200	100	76	46	30	18	14	12
	Side C/D	74	38	28	18	12	8	6	5



Series CT

Max. number of threaded holes

Type	ISO M	M12	M16	M20	M25	M32	M40	M50	M63
CT-50...	Side A/B	1	0	0	0	0	0	0	0
	Side C/D	1	0	0	0	0	0	0	0
CT-52...	Side A/B	2	0	0	0	0	0	0	0
	Side C/D	0	0	0	0	0	0	0	0
CT-54...	Side A/B	5	2	2	0	0	0	0	0
	Side C/D	2	1	0	0	0	0	0	0
CT-56...	Side A/B	10	5	3	2	1	1	1	0
	Side C/D	5	2	1	1	1	0	0	0
CT-58...	Side A/B	9	4	3	2	0	0	0	0
	Side C/D	2	1	1	0	0	0	0	0
CT-60...	Side A/B	15	6	6	3	2	1	1	0
	Side C/D	5	2	1	1	1	0	0	0
CT-62...	Side A/B	11	2	4	3	0	0	0	0
	Side C/D	2	1	1	0	0	0	0	0
CT-64...	Side A/B	22	10	8	5	3	2	2	0
	Side C/D	5	2	1	1	1	0	0	0
CT-66...	Side A/B	9	4	3	2	0	0	0	0
	Side C/D	4	3	2	0	0	0	0	0
CT-68...	Side A/B	15	6	6	3	2	1	1	0
	Side C/D	10	3	3	2	1	0	0	0
CT-72...	Side A/B	18	10	7	3	3	0	0	0
	Side C/D	9	5	2	2	1	0	0	0
CT-76...	Side A/B	26	12	8	5	3	0	0	0
	Side C/D	10	5	2	2	1	0	0	0
CT-78...	Side A/B	26	12	8	5	3	0	0	0
	Side C/D	10	5	2	2	1	0	0	0
CT-80...	Side A/B	34	17	12	6	5	3	3	2
	Side C/D	10	6	3	2	1	1	0	0
CT-82...	Side A/B	22	12	9	5	3	0	0	0
	Side C/D	12	6	3	2	2	0	0	0
CT-84...	Side A/B	36	16	12	8	4	2	2	2
	Side C/D	17	8	5	3	2	2	1	0
CT-86...	Side A/B	36	16	12	8	4	2	2	2
	Side C/D	17	8	5	3	2	2	1	0
CT-87...	Side A/B	34	14	10	6	4	0	0	0
	Side C/D	21	13	5	4	2	0	0	0
CT-88...	Side A/B	70	32	24	16	10	6	4	4
	Side C/D	26	11	8	5	3	2	2	1
CT-89...	Side A/B	34	14	10	6	4	0	0	0
	Side C/D	21	13	5	4	2	0	0	0
CT-90...	Side A/B	38	16	12	8	4	2	2	2
	Side C/D	17	8	5	3	2	2	1	0
CT-91...	Side A/B	38	16	12	8	4	2	2	2
	Side C/D	17	8	5	3	2	2	1	0

Series CP

Max. number of threaded holes

Type	ISO M	M12	M16	M20	M25	M32	M40	M50	M63
CP-140	Side A/B	5	2	2	1	0	0	0	0
	Side C/D	2	1	1	0	0	0	0	0
CP-145	Side A/B	8	4	2	1	1	0	0	0
	Side C/D	4	1	1	1	1	0	0	0
CP-150	Side A/B	8	3	2	2	0	0	0	0
	Side C/D	2	1	1	0	0	0	0	0
CP-155	Side A/B	12	6	3	2	2	2	0	0
	Side C/D	4	1	1	1	1	1	0	0
CP-170	Side A/B	12	5	4	3	0	0	0	0
	Side C/D	2	1	1	0	0	0	0	0
CP-175	Side A/B	18	10	6	4	3	0	0	0
	Side C/D	4	1	1	1	1	0	0	0
CP-190	Side A/B	16	7	5	4	0	0	0	0
	Side C/D	2	1	1	0	0	0	0	0
CP-195	Side A/B	24	12	8	4	3	0	0	0
	Side C/D	4	1	1	1	1	0	0	0
CP-220	Side A/B	13	6	4	3	2	1	0	0
	Side C/D	6	3	2	2	1	0	0	0
CP-240	Side A/B	27	12	9	6	4	3	0	0
	Side C/D	6	3	2	2	1	0	0	0
CP-280	Side A/B	18	8	6	4	2	2	1	0
	Side C/D	9	4	3	2	2	1	0	0
CP-300	Side A/B	33	15	12	8	4	3	3	0
	Side C/D	9	4	3	2	2	1	0	0
CP-320	Side A/B	48	23	18	11	7	5	4	0
	Side C/D	9	4	3	2	2	1	0	0
CP-330	Side A/B	76	40	28	18	10	8	6	0
	Side C/D	9	4	3	2	2	1	0	0
CP-370	Side A/B	42	23	17	11	7	4	3	3
	Side C/D	32	14	10	6	4	3	2	2
CP-400	Side A/B	74	38	27	17	13	6	5	4
	Side C/D	32	14	10	8	4	3	2	2
CP-450	Side A/B	74	38	27	17	13	6	5	4
	Side C/D	57	29	20	15	7	5	4	4
CP-460	Side A/B	105	56	40	27	20	10	9	8
	Side C/D	92	45	30	23	12	9	6	5



Standard enclosures

Accessories Overview

BERNSTEIN offers a complete placement service up to system solutions. BERNSTEIN can organise all the necessary components for you. A selection of the most common accessories is listed below.

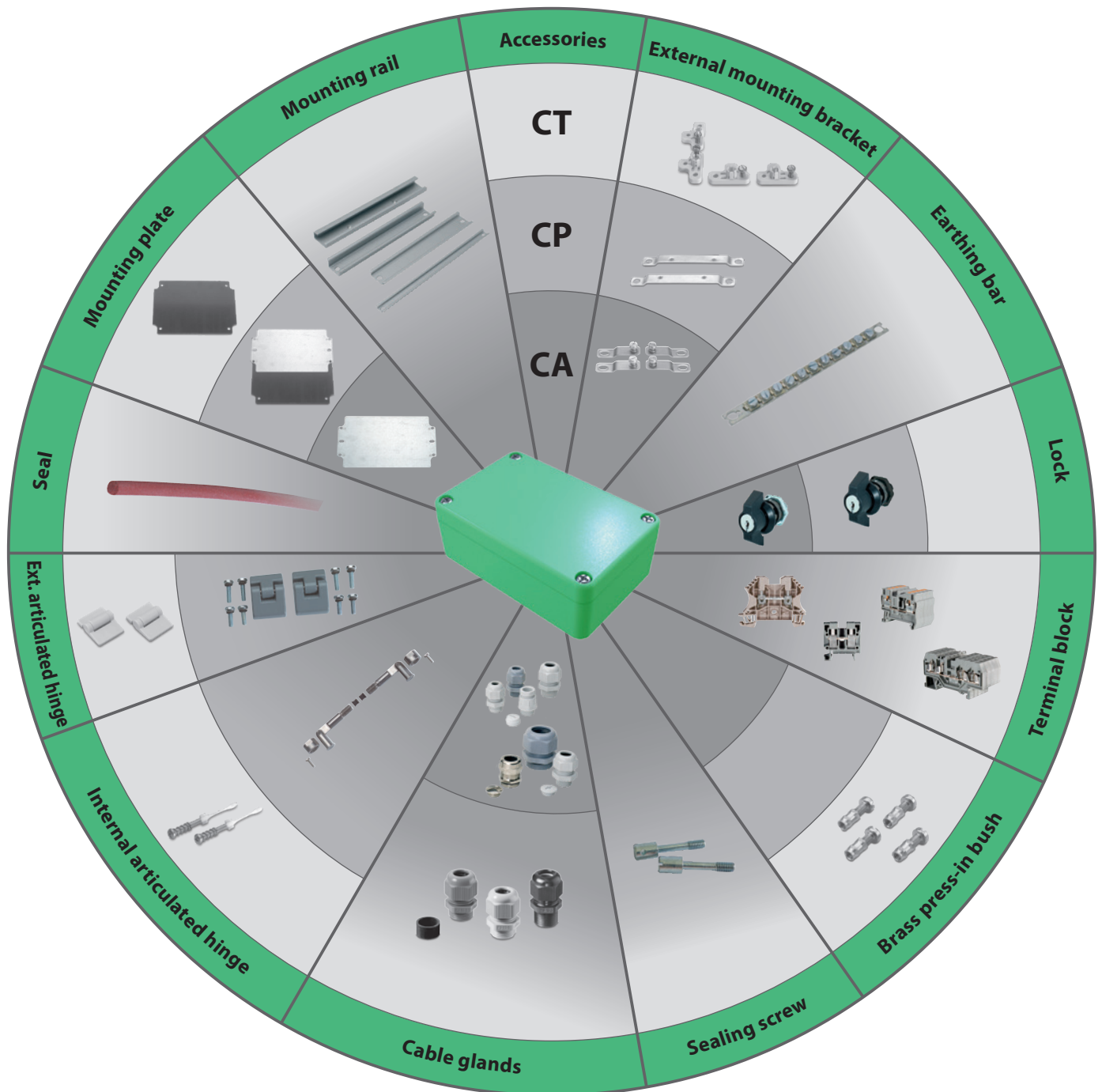

The graphic above shows at a glance which components are available for the respective enclosures.

Example: **CP** (to be read clockwise around the shaded ring):

External mounting brackets, earthing bars, locks, terminal blocks, NO press-in bushes, sealing screws, cable glands, internal articulated hinges, external articulated hinges, seals, mounting plates, mounting rails.

Notes

Diagrams. Sketches. Ideas.

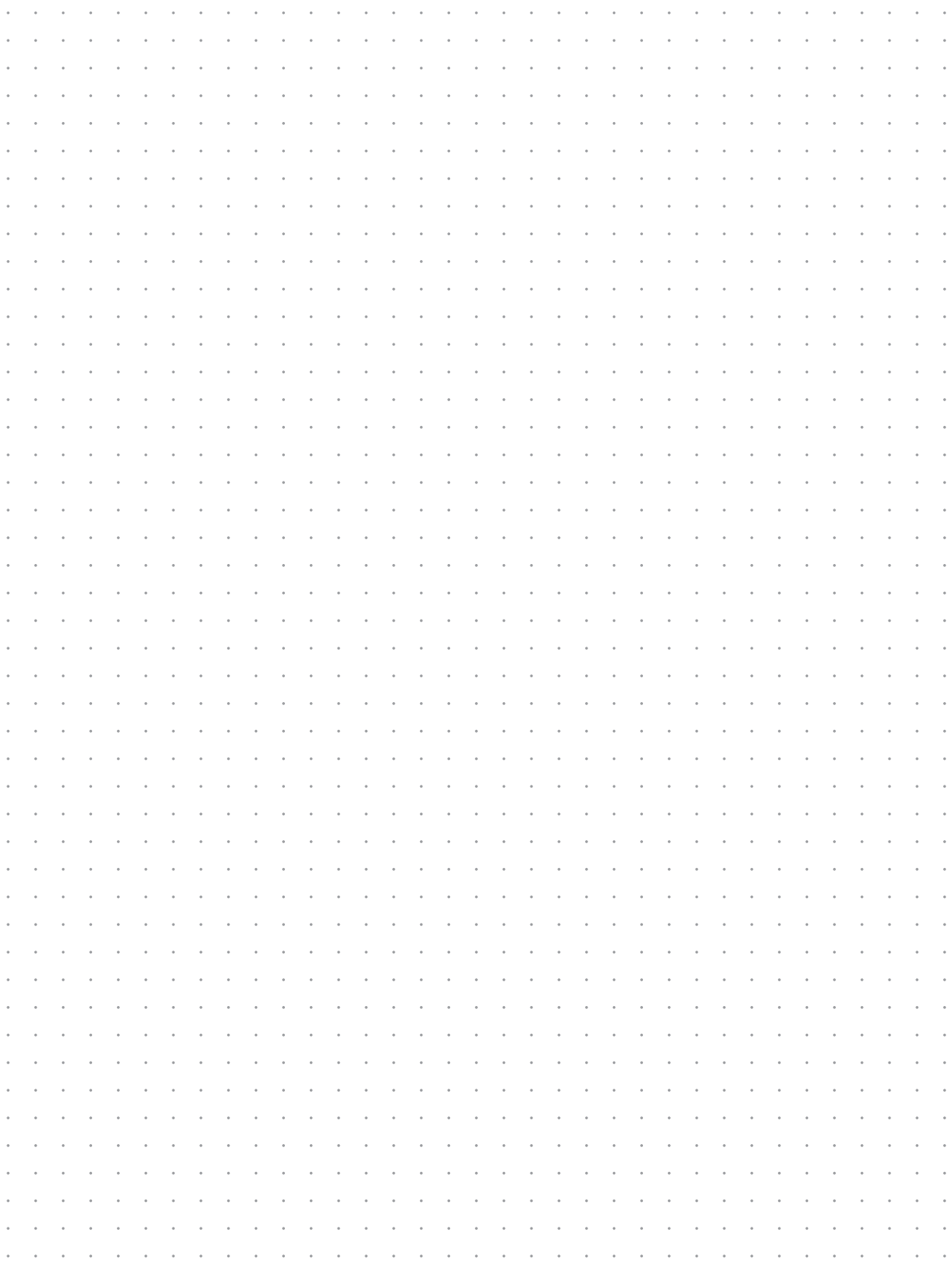

CA-Enclosures (Aluminium)

Details of the assembly components

Mounting plates

- Made from galvanised steel plate
(thickness: CA-060 to CA-310, CA-350 to CA-400: 1.5 mm;
CA-330, CA-420 to CA-480: 2.5 mm)
- For versatile mounting of built-in components



Mounting rails

- Conforming to Standards TS 15 or TS 32 and TS 35 and made from steel;
surface treated for accepting terminal blocks

Earthing bars

- Made from galvanised steel for combining and connecting PE conductors



External mounting brackets



- Made from stainless steel for mounting enclosures without
opening the covers
- Variable mounting in 90°-steps thanks to contours in the enclosure base

Terminal blocks

- Terminals of all well-known manufacturers can be offered
mounted according to the application



Sealing screw

- Use of a sealing screw to protect the cover against unauthorized access

External articulated hinges

- For hinged mounting of the enclosure cover
- Opening range of cover approx. 155°
- Cast aluminium (painted in RAL 7001 – specific colours possible according to the enclosure specification)
- Machining is required for mounting on enclosures



Internal articulated hinges



- For hinged mounting of the enclosure cover
- Opening range of cover approx. 95°
- Stainless steel
- Machining is required for mounting on enclosures

Silicon-, EPDM-, CR- or HF seal

- With increased temperature resistance (see indications on left side) or to protect sensitive electronic equipment against high-frequency radiation (HF seal)
- For a conductive connection, the grooves and springs of the enclosure must be left blank



Cable glands



- Plastic cable glands (polyamide PAG V-2, RAL 7001) or brass cable glands
- Sealing element CR/NBR, temperature range –20°C to +100°C
- Other cable glands are available on demand

Lock

- Use a lock to protect the enclosure against unauthorized access



CA-Enclosures

Available accessories



Article number Enclosure	Type	Mounting plate		Mounting rails			
		Material: Galvanised sheet steel	Thickness in mm	TS15	TS32	TS35	Earthing rail
1020000000	CA-020	-	-	-	-	-	-
1060000000	CA-060	X	1.5	X	-	-	-
1080000000	CA-080	X	1.5	X	-	-	-
1100000000	CA-100	X	1.5	X	-	-	-
1130000000	CA-130	X	1.5	X	-	-	-
1140000000	CA-140	X	1.5	X	-	-	-
1150000000	CA-150	X	1.5	X	-	-	-
1160000000	CA-160	X	1.5	X	-	-	-
1170000000	CA-170	X	1.5	X	-	-	-
1180000000	CA-180	X	1.5	X	-	-	-
1190000000	CA-190	X	1.5	X	-	-	-
1210000000	CA-210	X	1.5	X	X	X	X
1210000050	CA-215	X	1.5	-	X	X	X
1220000000	CA-220	X	1.5	-	X	X	X
1230000000	CA-230	X	1.5	-	X	X	X
1230000050	CA-235	X	1.5	-	X	X	X
1240000000	CA-240	X	1.5	-	X	X	X
1250000000	CA-250	X	1.5	-	X	X	X
1270000000	CA-270	X	1.5	-	X	X	X
1280000000	CA-280	X	1.5	-	X	X	X
1290000000	CA-290	X	1.5	-	X	X	X
1300000000	CA-300	X	1.5	-	X	X	X
1310000000	CA-310	X	1.5	-	X	X	X
1330000000	CA-330	X	2.5	-	X	X	X
1350000000	CA-350	X	1.5	-	X	X	X
1360000000	CA-360	X	1.5	-	X	X	X
1370000000	CA-370	X	1.5	-	X	X	X
1380000000	CA-380	X	1.5	-	X	X	X
1390000000	CA-390	X	1.5	-	X	X	X
1400000000	CA-400	X	1.5	-	X	X	X
1420000000	CA-420	X	2.5	-	X	X	X
1450000000	CA-450	X	2.5	-	X	X	X
1460000000	CA-460	X	2.5	-	X	X	X
1470000000	CA-470	X	2.5	-	X	X	X
1480000000	CA-480	X	2.5	-	X	X	X

x = available (can be ordered as an accessory, not included in scope of delivery)

- = not available

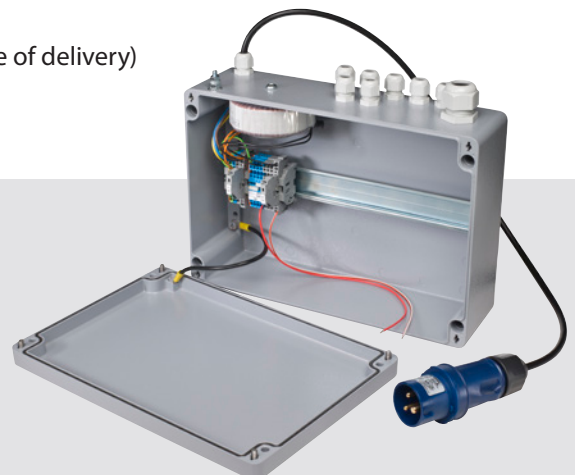

CT-Enclosures (Polycarbonate and ABS)

Details of the assembly components

Mounting rails

- Made from laminated paper (Pertinax)
(thickness: CT-50 to CT-60 1.5 mm; CT-62 to CT-78 2.0 mm;
CT-80 to CT-91 2.5 mm)
- For versatile mounting of built-in components



Mounting rails

- Conforming to standards TS15 or TS32 and TS 35, made from steel;
surface treated for accepting terminal blocks

Earthing bars

- Made from galvanised steel for combining and connecting PE conductors



External mounting brackets

- Made from polycarbonate for mounting enclosures without
opening the covers
- Different bracket arrangement options offset by 90°
- Colour RAL 7035

Terminal blocks

- Terminals of all well-known manufacturers can be offered
mounted according to the application



Sealing screw

- Use of a sealing screw protects the cover against unauthorized access

External articulated hinges

- Made from polycarbonate for hinged mounting of the enclosure cover
- Opening range of cover approx. 195°, latching at 170°, articulated hinges are simply pressed into holes (CT-88: secured by screws)

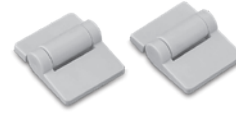

Flexible quick-release fastener / internal articulated hinges



- For captive mounting and strain relief for the enclosure cover
- Cover opening range >180°
- Stainless steel with injection-moulded polyamide ends

Silicon-, EPDM-, CR- or HF seal

- With increased temperature resistance (see indications on left side) or to protect sensitive electronic equipment against high-frequency radiation (HF seal)
- If a HF seal is used, an additional coating of the inside of the enclosure is required



Cable glands



- Plastic cable glands (polyamide 6, RAL 7035) including integrated strain relief
- Sealing element Neoprene, temperature range -20°C to +100°C
- Other cable glands are available on demand

Brass press-in bushes

- With metric fastening screws M3 (M4 on CT-88), for mounting built-in components with metric screws in the mounting bushes in the enclosure body



CT-Enclosures (Polycarbonate)

Available accessories



Article number Enclosure with quick-release fastener	Type	Screw fastener	Mounting plate		Mounting rails			
			Material: HP 2061	Thickness in mm	TS15	TS32	TS35	Earthing rail
2500000000	CT-501	X	X	1.5	-	-	-	-
2520000000	CT-521	X	X	1.5	X	-	-	-
2540000000	CT-541	X	X	1.5	X	-	X	-
2560000000	CT-561	X	X	1.5	X	-	X	-
2580000000	CT-581	X	X	1.5	X	-	X	X
2600000000	CT-601	X	X	1.5	X	-	X	X
2620000000	CT-621	X	X	2	X	-	X	X
2640000000	CT-641	X	X	2	X	-	X	X
2660000000	CT-661	X	X	2	X	-	X	X
2680000000	CT-681	X	X	2	-	X	X	X
2720000000	CT-721	X	X	2	-	X	X	X
2760000000	CT-761	X	X	2	-	X	X	X
2780000000	CT-781	X	X	2	-	X	X	X
2800000000	CT-801	X	X	2.5	-	X	X	X
2820000000	CT-821	X	X	2.5	-	X	X	X
2840000000	CT-841	X	X	2.5	-	X	X	X
2860000000	CT-861	X	X	2.5	-	X	X	X
2900000000	CT-901	X	X	2.5	-	X	X	X
2910000000	CT-911	X	X	2.5	-	X	X	X
2880000000	CT-881	X	X	2.5	-	X	X	X
2870000000	CT-871	X	X	2.5	-	X	X	X
2890000000	CT-891	X	X	2.5	-	X	X	X
2501000000	CT-501 T	X	X	1.5	-	-	-	-
2521000000	CT-521 T	X	X	1.5	X	-	-	-
2541000000	CT-541 T	X	X	1.5	X	-	X	-
2561000000	CT-561 T	X	X	1.5	X	-	X	-
2581000000	CT-581 T	X	X	1.5	X	-	X	X
2601000000	CT-601 T	X	X	1.5	X	-	X	X
2621000000	CT-621 T	X	X	2	X	-	X	X
2641000000	CT-641 T	X	X	2	X	-	X	X
2661000000	CT-661 T	X	X	2	X	-	X	X
2681000000	CT-681 T	X	X	2	-	X	X	X
2721000000	CT-721 T	X	X	2	-	X	X	X
2761000000	CT-761 T	X	X	2	-	X	X	X
2781000000	CT-781 T	X	X	2	-	X	X	X
2801000000	CT-801 T	X	X	2.5	-	X	X	X
2821000000	CT-821 T	X	X	2.5	-	X	X	X
2841000000	CT-841 T	X	X	2.5	-	X	X	X
2861000000	CT-861 T	X	X	2.5	-	X	X	X
2901000000	CT-901 T	X	X	2.5	-	X	X	X
2911000000	CT-911 T	X	X	2.5	-	X	X	X
2881000000	CT-881 T	X	X	2.5	-	X	X	X
2871000000	CT-871 T	X	X	2.5	-	X	X	X
2891000000	CT-891 T	X	X	2.5	-	X	X	X

x = available (can be ordered as an accessory, not included in scope of delivery)

- = not available

CT-Enclosures (ABS)

Available accessories



Article number Enclosure with quick-release fastener	Type	Screw fastener	Mounting plate		Mounting rails			
			Material: HP 2061	Thickness in mm	TS15	TS32	TS35	Earthing rail
3500000000	CT-502	X	X	1.5	-	-	-	-
3520000000	CT-522	X	X	1.5	X	-	-	-
3540000000	CT-542	X	X	1.5	X	-	X	-
3560000000	CT-562	X	X	1.5	X	-	X	-
3580000000	CT-582	X	X	1.5	X	-	X	X
3600000000	CT-602	X	X	1.5	X	-	X	X
3620000000	CT-622	X	X	2	X	-	X	X
3640000000	CT-642	X	X	2	X	-	X	X
3660000000	CT-662	X	X	2	X	-	X	X
3680000000	CT-682	X	X	2	-	X	X	X
3720000000	CT-722	X	X	2	-	X	X	X
3760000000	CT-762	X	X	2	-	X	X	X
3780000000	CT-782	X	X	2	-	X	X	X
3800000000	CT-802	X	X	2.5	-	X	X	X
3820000000	CT-822	X	X	2.5	-	X	X	X
3840000000	CT-842	X	X	2.5	-	X	X	X
3860000000	CT-862	X	X	2.5	-	X	X	X
3900000000	CT-902	X	X	2.5	-	X	X	X
3910000000	CT-912	X	X	2.5	-	X	X	X
3880000000	CT-882	X	X	2.5	-	X	X	X
3870000000	CT-872	X	X	2.5	-	X	X	X
3890000000	CT-892	X	X	2.5	-	X	X	X
3501000000	CT-502 T	X	X	1.5	-	-	-	-
3521000000	CT-522 T	X	X	1.5	X	-	-	-
3541000000	CT-542 T	X	X	1.5	X	-	X	-
3561000000	CT-562 T	X	X	1.5	X	-	X	-
3581000000	CT-582 T	X	X	1.5	X	-	X	X
3601000000	CT-602 T	X	X	1.5	X	-	X	X
3621000000	CT-622 T	X	X	2	X	-	X	X
3641000000	CT-642 T	X	X	2	X	-	X	X
3661000000	CT-662 T	X	X	2	X	-	X	X
3681000000	CT-682 T	X	X	2	-	X	X	X
3721000000	CT-722 T	X	X	2	-	X	X	X
3761000000	CT-762 T	X	X	2	-	X	X	X
3781000000	CT-782 T	X	X	2	-	X	X	X
3801000000	CT-802 T	X	X	2.5	-	X	X	X
3821000000	CT-822 T	X	X	2.5	-	X	X	X
3841000000	CT-842 T	X	X	2.5	-	X	X	X
3861000000	CT-862 T	X	X	2.5	-	X	X	X
3901000000	CT-902 T	X	X	2.5	-	X	X	X
3911000000	CT-912 T	X	X	2.5	-	X	X	X
3881000000	CT-882 T	X	X	2.5	-	X	X	X
3871000000	CT-872 T	X	X	2.5	-	X	X	X
3891000000	CT-892 T	X	X	2.5	-	X	X	X

x = available (can be ordered as an accessory, not included in scope of delivery)

- = not available

CP-Enclosures (Polyester)

Details of the assembly components

Mounting plates

- Made from galvanised steel plate or laminated paper (thickness: CP-140 to CP-195 laminated paper 1.5 mm; CP-220 to CP-320 and CP-370 to CP-460 steel plate 1.5 mm; CP-330 steel plate 2.5 mm)
- For versatile mounting of built-in components

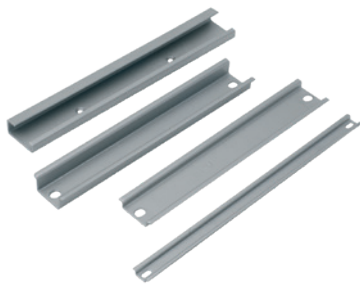
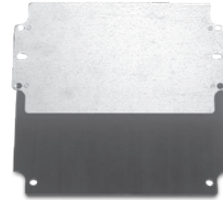

Mounting rails

- Conforming to Standards TS 15 or TS 32 and TS 35, made from steel; surface treated for accepting terminal blocks

Earthing bars

- Made from galvanised steel for combining and connecting PE conductors



External mounting brackets

- Made from metal for mounting enclosures without opening the covers
- The brackets are always fitted across the shorter sides of the enclosure

Terminal blocks

- Terminals of all well-known manufacturers can be offered mounted according to the application



Sealing screw

- Use of a sealing screw protects the cover against unauthorized access

External articulated hinges

- For hinged mounting of the enclosure cover
- Opening range of cover approx. 155°
- Cast aluminium (painted in RAL 7001 – specific colours possible according to enclosure specification)
- Machining is required for mounting on enclosures



Internal articulated hinges



- For hinged mounting of enclosure cover
- Opening range of cover approx. 95°
- Stainless steel
- Machining is required for mounting on enclosures

Silicon-, EPDM-, CR- or HF seal

- With increased temperature resistance (see indications on left side) or to protect sensitive electronic equipment against high-frequency radiation (HF seal)
- If a HF seal is used, an additional coating of the inside of the enclosure is required



Cable glands



- Plastic cable glands (polyamide PAG V-2, RAL 7001)
- Sealing element CR/NBR
- Temperature range –20°C to +100°C
- Other cable glands are available on demand

Lock

- Use a lock to protect the enclosure against unauthorized access



CP-Enclosures

Available accessories



Article number Enclosure	Type	Material	Thickness in mm	Mounting plate			Mounting rails	
				TS15	TS32	TS35	Earthing rail	
414000000	CPG-140	HP 2061	2	X	-	-	-	
414000050	CPG-145	HP 2061	2	X	-	-	-	
415000000	CPG-150	HP 2061	2	X	-	-	-	
415000050	CPG-155	HP 2061	2	X	-	-	-	
417000000	CPG-170	HP 2061	2	X	-	-	-	
417000050	CPG-175	HP 2061	2	X	-	-	-	
419000000	CPG-190	HP 2061	2	X	-	-	-	
419000050	CPG-195	HP 2061	2	X	-	-	-	
422000000	CPG-220	Galvanised sheet steel	1.5	-	X	X	X	
424000000	CPG-240	Galvanised sheet steel	1.5	-	X	X	X	
428000000	CPG-280	Galvanised sheet steel	1.5	-	X	X	X	
430000000	CPG-300	Galvanised sheet steel	1.5	-	X	X	X	
432000000	CPG-320	Galvanised sheet steel	1.5	-	X	X	X	
433000000	CPG-330	Galvanised sheet steel	2.5	-	X	X	X	
437000000	CPG-370	Galvanised sheet steel	1.5	-	X	X	X	
440000000	CPG-400	Galvanised sheet steel	1.5	-	X	X	X	
445000000	CPG-450	Galvanised sheet steel	1.5	-	X	X	X	
446000000	CPG-460	Galvanised sheet steel	1.5	-	X	X	X	
514000000	CPS-140	HP 2061	2	X	-	-	-	
514000050	CPS-145	HP 2061	2	X	-	-	-	
515000000	CPS-150	HP 2061	2	X	-	-	-	
515000050	CPS-155	HP 2061	2	X	-	-	-	
517000000	CPS-170	HP 2061	2	X	-	-	-	
517000050	CPS-175	HP 2061	2	X	-	-	-	
519000000	CPS-190	HP 2061	2	X	-	-	-	
519000050	CPS-195	HP 2061	2	X	-	-	-	
522000000	CPS-220	Galvanised sheet steel	1.5	-	X	X	X	
524000000	CPS-240	Galvanised sheet steel	1.5	-	X	X	X	
528000000	CPS-280	Galvanised sheet steel	1.5	-	X	X	X	
530000000	CPS-300	Galvanised sheet steel	1.5	-	X	X	X	
532000000	CPS-320	Galvanised sheet steel	1.5	-	X	X	X	
533000000	CPS-330	Galvanised sheet steel	2.5	-	X	X	X	
537000000	CPS-370	Galvanised sheet steel	1.5	-	X	X	X	
540000000	CPS-400	Galvanised sheet steel	1.5	-	X	X	X	
545000000	CPS-450	Galvanised sheet steel	1.5	-	X	X	X	
546000000	CPS-460	Galvanised sheet steel	1.5	-	X	X	X	

x = available (can be ordered as an accessory, not included in scope of delivery)

- = not available

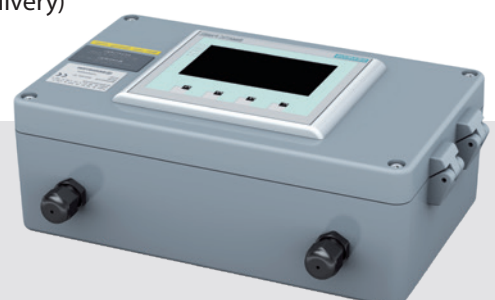

BERNSTEIN

Your partner for explosion protection

OUR PROMISE TO YOU

- The right product for your application
- Professional technical advice
- Engineering and project management from one provider
- Continuously monitored quality system
- Customer specific developments and approvals
- The right contact for all matters concerning explosion protection and machinery safety
- Product and professional trainings for Ex applications
- Specialists who always have the latest know-how from internal and external basic and further training courses

You can be sure of that.



Ex competence for potentially explosive areas

TERMINAL ENCLOSURES AND EMPTY ENCLOSURES

Only materials that correspond to the temperature range required for Ex enclosures are used in these enclosures and components. The minimum type of protection rating of all enclosures and screw connections is IP64, other protection classes available on request. The latching devices on the enclosures are available as captive screw connections. Various CA versions are available with flange plates. All built-in components must conform to the relevant approvals.

EX-APPROVED PRODUCTS FOR POTENTIALLY EXPLOSIVE ATMOSPHERES

- Ex e, Ex ia and Ex e / ia terminal boxes made from polyester and aluminium
- Ex d / Ex tb limit switches, rope pull switches and foot switches
- Ex mb / Ex tb magnetic switches
- Ex ib inductive namur sensors

OUR EX-EXPERTS' SERVICES:

- Approvals assistance for plant operators
- Approval of switching and control elements in all enclosures
- Approval of plug-in devices in all enclosures
- Customised component mounting and wiring of enclosures
- Training courses for planners and plant operators
- Cross-product system solutions
- Customer-specific development and project management on request
- Approval according to IEC Ex on request



Aluminium and polyester blank enclosures

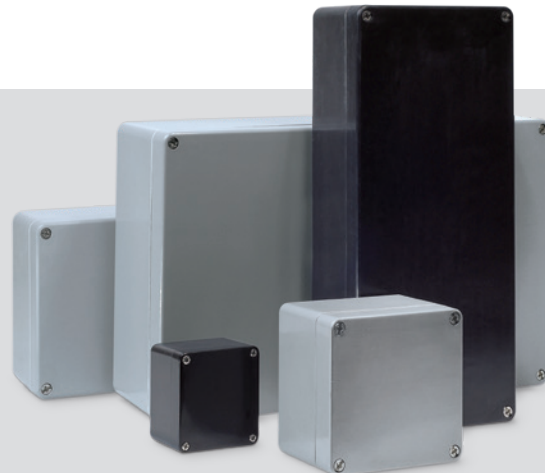

CA, CP, CPS



ATEX-U certified standard enclosures

BERNSTEIN enclosures have been tested by an internationally recognised and certified inspection authority and certified through type approval testing for use in areas with potentially explosive dust and gas atmospheres. Used as terminal and control enclosures, the aluminium pressure die-cast (CA) and glass-fibre reinforced polyester (CPG, CPS) enclosures are designed to accept corresponding mechanical and electrical equipment. The enclosures come with operating instructions, type identification plate and CE Declaration of Conformity. Either an EPDM or silicone seal can be used. The enclosures can be fitted at the factory with external hinges.

Technical Data

- Protection class IP66 to IEC 60529
- Ex-Identification
 -  II 2G Ex eb IIC Gb
 -  II 2D Ex tb IIIC Db
- Impact strength > 7 joules
- Operating temperature max. -55 °C to +135 °C (special seal)
- Enclosure colour:
 - CA** RAL 7001 (silver grey)
Powder-coating corrosion protection
 - CP/CPS** RAL 7000 (squirrel grey) CP
RAL 9005 (jet black) CPS
- UV resistance
- Certificates:
 - CA** IBExU 16 ATEX 1130 U, IECEx IBE 15.0025U
 - CP/CPS** IBExU 16 ATEX 1197 U, IECEx IBE 16.0036U

Ordering data blank enclosures

CA, CP, CPS



Type	External dimension (mm)	Art.No. with silicone seal	Art.No. with EPDM seal
CA-060	58 × 64 × 36	1064005000	1064000000
CA-080	98 × 64 × 36	1084005000	1084000000
CA-100	150 × 64 × 36	1104005000	1104000000
CA-130	75 × 80 × 57	1134005000	1134000000
CA-150	125 × 80 × 57	1154005000	1154000000
CA-170	175 × 89 × 57	1174005000	1174000000
CA-190	250 × 80 × 57	1194005000	1194000000
CA-210	122 × 122 × 80	1214005000	1214000000
CA-215	122 × 122 × 90	1214005050	1214000050
CA-220	122 × 122 × 80	1224005000	1224000000
CA-230	220 × 122 × 80	1234005000	1234000000
CA-235	220 × 122 × 90	1234005050	1234000050
CA-240	220 × 122 × 80	1244005000	1244000000
CA-250	360 × 122 × 80	1254005000	1254000000
CA-270	160 × 160 × 90	1274005000	1274000000
CA-280	160 × 160 × 90	1284005000	1284000000
CA-290	260 × 160 × 90	1294005000	1294000000
CA-300	260 × 160 × 90	1304005000	1304000000
CA-310	360 × 160 × 90	1314005000	1314000000
CA-330	560 × 160 × 90	1334005000	1334000000
CA-350	200 × 230 × 110	1354005000	1354000000
CA-360	200 × 230 × 180	1364005000	1364000000
CA-370	280 × 230 × 110	1374005000	1374000000
CA-380	330 × 230 × 110	1384005000	1384000000
CA-390	330 × 230 × 180	1394005000	1394000000
CA-400	400 × 230 × 110	1404005000	1404000000
CA-420	600 × 230 × 110	1424005000	1424000000
CA-450	402,5 × 310 × 110	1454005000	1454000000
CA-460	402,5 × 310 × 180	1464005000	1464000000
CA-470	600 × 310 × 110	1474005000	1474000000
CA-480	600 × 310 × 180	1484005000	1484000000
CP-140	80 × 75 × 55	4144005000	4144000000
CP-145	80 × 75 × 75	4144005050	4144000050
CP-150	110 × 75 × 55	4154005000	4154000000
CP-155	110 × 75 × 75	4154005050	4154000050
CP-170	160 × 75 × 55	4174005000	4174000000
CP-175	160 × 75 × 75	4174005050	4174000050
CP-190	190 × 75 × 55	4194005000	4194000000
CP-195	190 × 75 × 75	4194005050	4194000050
CP-220	122 × 120 × 90	4224005000	4224000000
CP-240	220 × 120 × 90	4244005000	4244000000
CP-280	160 × 160 × 90	4284005000	4284000000
CP-300	260 × 160 × 90	4304005000	4304000000
CP-320	360 × 160 × 90	4324005000	4324000000
CP-330	560 × 160 × 90	4334005000	4334000000
CP-370	255 × 250 × 120	4374005000	4374000000
CP-400	400 × 250 × 120	4404005000	4404000000
CP-450	400 × 405 × 120	4454005000	4454000000
CPS-140	80 × 75 × 55	5144005000	5144000000
CPS-145	80 × 75 × 75	5144005050	5144000050
CPS-150	110 × 75 × 55	5154005000	5154000000
CPS-155	110 × 75 × 75	5154005050	5154000050
CPS-170	160 × 75 × 55	5174005050	5174000050
CPS-175	160 × 75 × 75	5174005050	5174000050
CPS-190	190 × 75 × 55	5194005000	5194000000
CPS-195	190 × 75 × 75	5194005050	5194000050
CPS-220	122 × 120 × 90	5224005000	5224000000
CPS-240	220 × 120 × 90	5244005000	5244000000
CPS-280	160 × 160 × 90	5284005000	5284000000
CPS-300	260 × 160 × 90	5304005000	5304000000
CPS-320	360 × 160 × 90	5324005000	5324000000
CPS-330	560 × 160 × 90	5334005000	5334000000
CPS-370	255 × 250 × 120	5374005000	5374000000
CPS-400	400 × 250 × 120	5404005000	5404000000
CPS-450	400 × 405 × 120	5454005000	5454000000

Aluminium and Polyester Terminal enclosures

The Ex standard enclosures of the CA and CP series are designed as fully machined and assembled connection and wiring enclosures for use in zones 1, 2, 21 and 22. They are machined and assembled according to the customer's needs and wishes. A combination of terminals and cable glands of various manufacturers is possible.

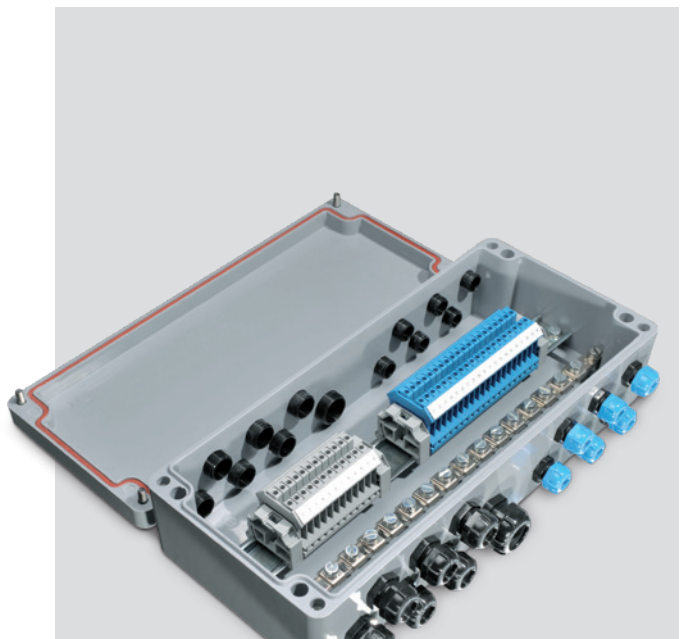
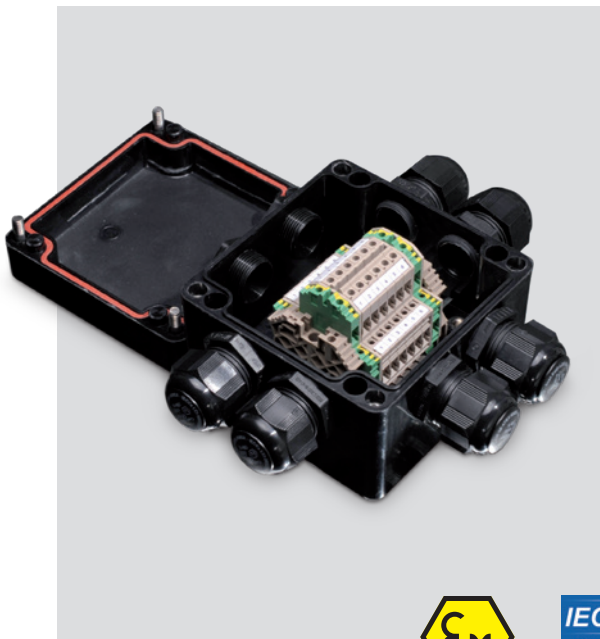

All common connecting terminals and cable glands can be combined.

- Screw terminals
- Direct push in terminals
- Wire piercing clamps
- Quick connect push terminals
- Single screw-type metal or plastic glands
- Multiple screw-type metal or plastic glands
- Special screw type glands for ribbon cables
- Certificates:

CA IBExU 16 ATEX 1131, IECEx IBE 15.0029

CP/CPS IBExU 16 ATEX 1198 X, IECEx IBE 16.0037X

The enclosures are designed in "enhanced safety" and "intrinsic safety" protection types or a combination of both.

A protection type up to IP66 in accordance with ISO 60529 is possible depending on the seal. The operating temperature ranges from $-55\text{ }^{\circ}\text{C}$ to $+130\text{ }^{\circ}\text{C}$ depending on the version.

All sizes of the blank enclosures are available as assembled enclosures. Either an earthing rail or an earthing clamp is used as an earth connection.



Cable glands, plastic M12-M63

- Temperature range -20 °C to +80 °C, PA6
- IP66/68, Ex e and Ex i



Cable glands, metal M12-M63

- Temperature range -30 °C to +90 °C, MS
- IP66/68, Ex e

Screw terminals

- TS15 (Standard), TS35 (Standard)
- MUT 2.5
- UT 2.5

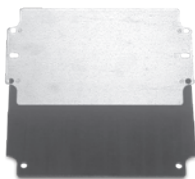
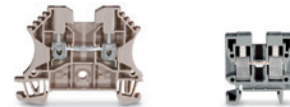

Mounting plates

- Made from galvanised steel plate or laminated paper
- As from CP-370/CA
- Up to CP-320

External mounting brackets

- For mounting without opening the covers
- Stainless steel



Mounting rails

- TS-15 or TS-35
- As from CA-210/CP-220
- Up to CA-190/CP-195

Earthing bars

- As option to PE terminals
- Solid earthing brass nickel-plated
- As from CA-210/CP-220



Monitor enclosures for zone 2/22

To enable the use of controllers and operating units in explosive areas of zones 2 and 22, monitor and controller enclosures of the CC-4000 series and the CA and CP series with customised assemblies can be used.



Zone 2

For operation in zone 2 (Gas 3G) the enclosures are designed to ensure explosion protection type Ex nA (non-sparking device) and/or Ex i (intrinsic safety). The basic preconditions for this are:

- Enclosure and suspension system protection class IP54
- All add-on and built-in parts with type examination certificates or CE declaration of conformity for zone 2

Zone 22

For operation in zone 22 (Dust 3D) the enclosures are designed to ensure explosion protection type tc (protection by enclosure). The basic preconditions for this are:

- Enclosure and suspension system protection class IP6x
- All add-on parts with type examination certificates or rather CE declaration of conformity for zone 22
- The assembly of all externally accessible parts at BERNSTEIN AG
- Issuing of a manufacturer declaration/CE declaration of conformity for the complete enclosure
- Documentation and monitored production by ATEX-QA



Accessories, built-in and add-on parts

Parts of all renowned manufacturers are used.
This include:

- Operator panel parts
- Terminals
- Touch panels
- Cable glands
- Power devices
- IPC Panels
- Signal lamps
- Alphanumeric displays



DEFINITION OF PROTECTION CLASSES

IN ACCORDANCE WITH DIN EN 60529, VDE 470 T 1

The protection class of an enclosed device denotes the degree of protection. The degree of protection includes the protection of persons against contact with parts under voltage and the protection of equipment against the infiltration of foreign bodies and water. BERNSTEIN standard enclosures largely correspond to protection class IP67.

Foreign body protection

1. digit	Meaning	Explanation
IP0X	No protection	
IP1X	Protection against foreign bodies with a diameter of 50 mm or greater	Solid object (sphere, Ø 50 mm) must not fully penetrate
IP2X	Protection against foreign bodies with a diameter of 12.5 mm or greater	Solid object (sphere, Ø 12.5 mm) must not fully penetrate
IP3X	Protection against foreign bodies with a diameter of 2.5 mm or greater	Solid object (sphere, Ø 2.5 mm) must not fully penetrate
IP4X	Protection against foreign bodies with a diameter of 1 mm or greater	Solid object (sphere, Ø 1 mm) must not fully penetrate
IP5X	Protection against harmful dust deposits	Dust penetration is not completely prevented. However, the amount of penetration must not impair the function or safety of the device
IP6X	Protection against dust penetration, dustproof	No penetration of dust at a negative pressure of 20 mbar in the enclosure

Moisture protection

2. digit	Meaning	Explanation
IPX0	No protection	
IPX1	Protection against dripping water	Vertically falling droplets must not have a damaging effect
IPX2	Protection against dripping water when the enclosure is tilted at an angle of up to 15°	Vertically falling droplets must not have a damaging effect when the enclosure is tilted at an angle of up to 15° either side of the perpendicular
IPX3	Protection against spray water	Water splashed at an angle of up to 60° either side of the perpendicular must not have a damaging effect
IPX4	Protection against splash water	Water sprayed against the enclosure from any direction must not have a damaging effect
IPX5	Protection against hose water	Water sprayed in jet form against the enclosure from any direction must not have a damaging effect
IPX6	Protection against strong hose water	Water sprayed in a strong jet form against the enclosure from any direction must not have a damaging effect
IPX7	Protection against the effect when temporarily submerged in water	Water must not enter in harmful quantities when the enclosure is submerged under standardised pressure and time conditions
IPX8	Protection against the effects of continuous immersion in water	Water may not ingress in a volume that would cause harmful effects when the shell is continuously submerged in water under conditions agreed between manufacturer and user . The conditions must, however, be more difficult than those for code number IPX7.
IPX9K	Protection against water during high pressure/steam jet cleaning (as per DIN EN 40050, Part 9)	Water sprayed at greatly increased pressure against the enclosure from any direction must not have a damaging effect

DEFINITION OF THE PROTECTION CLASS IN ACCORDANCE WITH IEC 62262

- Degrees of protection against external mechanical stress provided by enclosures for electrical equipment (equipment) (IK code)
- The IK code is internationally standardised according to IEC 62262 (refers to EN 50102)
- There are ten codes corresponding to the impact energy [Joule] assigned

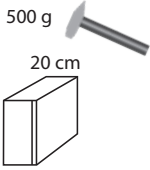
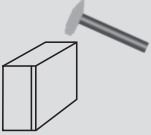
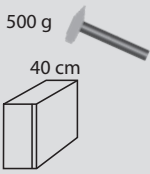
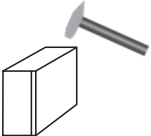
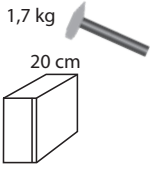
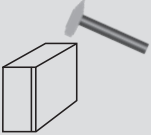
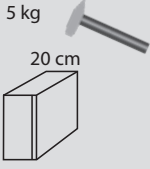
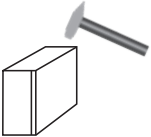
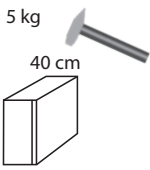
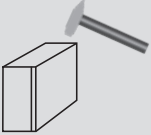
IK-Code	[W] in J		IK-Code	[W] in J	
IK00	no protection		IK06	1	
IK01	0.14		IK07	2	
IK02	0.2		IK08	5	
IK03	0.35		IK09	10	
IK04	0.5		IK10	20	
IK05	0.7				

ENCLOSURE MATERIAL CHEMICAL RESISTANCE

Chemical	ABS	Polycarbonate	Polyester	Aluminium
Acetone	-	-	-	+
Formic acid	40%	-	+	o
Ammonia	25%	-	-	+
Petrol	-	o	+	+
Benzene	-	-	+	+
Brake fluid	o	-	+	o
Butane	+	+	+	+
Butanol	o	o	+	o
Calcium chloride	+	+	+	+
Chlorobenzene	-	-	+	+
Diesel oil	+	o	+	o
Acetic acid	25%	10%	5%	+
Formaldehyde	30%	o	30%	+
Freon 113	-	+	+	o
Fruit juice	+	+	+	o
Glycerine	+	o	+	+
Fuel oil	o	o	+	+
Hydraulic oil	o	+	+	o
Caustic potash solution	50%	-	-	o
Potassium chloride	o	+	+	o
Potassium hydroxide	< = 50 %	o	5%	-
Linseed oil	+	+	+	+
Methanol	+	-	+	+
Methylene chloride	-	-	+	+
Lactic acid	80%	+	+	+
Mineral oils	+	+	+	o
Engine oils	+	+	+	o
Sodium carbonate	+	+	10%	o
Sodium chloride	+	+	+	o
Sodium hydroxide	+	o	5%	+
Caustic soda	50%	-	40%	o
Nitric acid	-	10%	10%	+
Hydrochloric acid	o	20%	+	+
Lubricating oil	o	+	+	+
Carbon disulphide	-	-	-	+
Sulphuric acid	50%	50%	10%	o
Soap solution	o	o	+	o
Detergent	o	+	o	o
Turpentine oil	o	o	+	o
Carbon tetrachloride	-	-	+	+
Toluene	-	-	+	+
Trichloroethylene	-	-	+	+
Water (distilled water, river water, tap water, sea water)	+	+	+	o
Tartaric acid	+	+	+	o
Xylene	-	-	+	+
Zinc sulphate	+	+	+	o
Citric acid	+	10%	+	+

+: Resistant to all concentrations

o: Resistant to max. % concentrations

o: Conditionally resistant

-: Not resistant

o: No data

() : Estimated value

ENCLOSURE SEALS

CHEMICAL RESISTANCE

Chemical	Polyurethane (Standard)	CR	Silicone	NBR
Acetone	-	o	-	-
Formic acid	-	o	+	-
Ammonia	+/-	10%	+	o
Petrol	-	o	-	o
Benzene	□	-	-	-
Brake fluid	-	o	+	-
Butane	□	+	-	+
Butanol	-	+	-	o
Calcium chloride	+ (watery)	□	□	+
Chlorobenzene	-	-	-	-
Diesel oil	o	o	-	□
Acetic acid	+/-	-	o	-
Formaldehyde	□	□	+	o
Freon 113	□	o	□	+
Fruit juice	□	+	+	o
Glycerine	+	+	+	+
Fuel oil	□	o	o	+
Hydraulic oil	□	□	o	o
Caustic potash solution	□	+	-	o
Potassium chloride	□	+	+	+
Potassium hydroxide	-	o	o	+
Linseed oil	o	+	+	+
Methanol	+/-	+	+	o
Methylene chloride	-	-	-	-
Lactic acid	□	+	□	o
Mineral oils	+/-	o	o	+
Engine oils	□	o	+	+
Sodium carbonate	□	□	+	+
Sodium chloride	+	+	+	+
Sodium hydroxide	-	50%	o	o
Caustic soda	□	50%	< 10%	o
Nitric acid	-	-	< 10%	-
Hydrochloric acid	o < 10%	o	< 10%	-
Lubricating oil	□	o	+	+
Carbon disulphide	□	-	-	-
Sulphuric acid	- (concentrated)	50%	o	-
Soap solution	+	□	+	+
Detergent	□	o	+	+
Turpentine oil	+/-	□	-	o
Carbon tetrachloride	-	-	-	-
Toluene	-	-	-	-
Trichloroethylene	-	-	-	-
Water (distilled water, river water, tap water, sea water)	+	+	+	80°C
Tartaric acid	□	o	+	+
Xylene	-	-	-	-
Zinc sulphate	□	+	+	+
Citric acid	+	+	+	+

+ : Resistant to all concentrations

% : Resistant to max. % concentrations

o : Conditionally resistant

- : Not resistant

□ : No data

+/- : Suitability strongly influenced by the specific substance or concentration

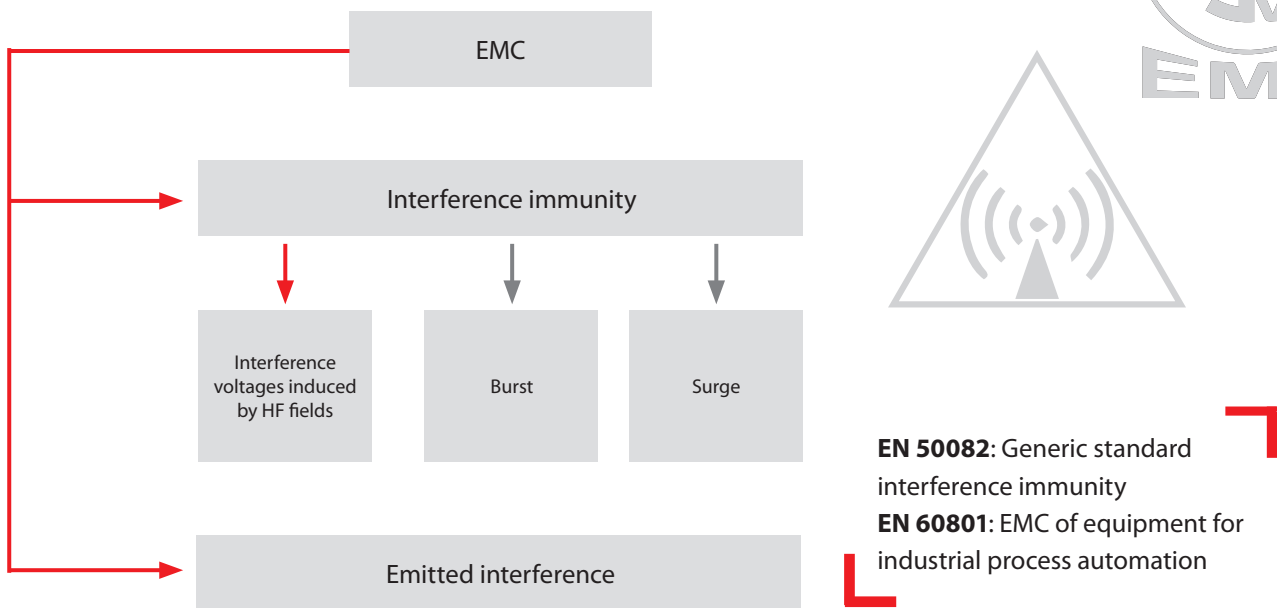

As a supplier of enclosures, BERNSTEIN inevitably works at the interface between the resulting and received interference or radiation. According to the definition, enclosures are not electrical or electronic devices that are disturbed or can themselves be disturbed by HF radiation (EMC Directive 2014/30/EU of the European Parliament). However, for many applications, enclosures are required to protect electronics from external influences. Enclosures in the appropriate design are therefore also of decisive importance for interference emission or the immunity of devices.

How are enclosures designed according to EMC?

Choice of materials

Conductive enclosure materials are, of course, optimal shielding materials in the first instance. The BERNSTEIN aluminum enclosures of the CA series are therefore ideal for shielding electrical and electronic equipment. Plastic enclosures can be made HF-tight by coating them with conductive materials. Also here BERNSTEIN offers a corresponding solution. Both the thermoplastic enclosures of the CT series, made of polycarbonate and ABS as well as the polyester enclosures are internally coated with aluminum.

Interface cover / bottom

The IP protection class is ensured by the NUT spring system, which is provided with a seal. In order to make the enclosure insensitive to electromagnetic waves, an HF/ EMC gasket can be used which, depending on the requirements, can be made of a silicone gasket with an appropriate silver coating.

For further information please
contact us!

Fire classification tests are carried out to investigate the burning properties and thus the fire safety of plastics.

Flammability UL 94 HB

A test for testing the horizontal burning behaviour. A standardised plastic sample is clamped horizontally. A torch is then used to flame the sample for 30 seconds. The resulting burning time of the plastic is measured and a conclusion is made about the flammability.



Flammability UL 94 V

A test for testing the vertical burning behaviour of plastic samples. The sample is fixed vertically and then flamed with the burner for 2x10 seconds. The plastic specimens are classified according to whether the specimen is subject to burning or dripping.

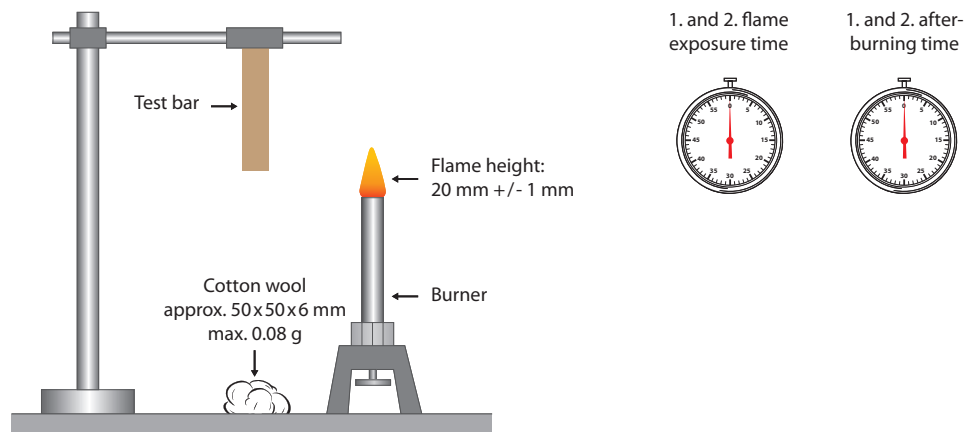

Flammability class UL 94

	V-0	V-1	V-2
Afterburning time after flame treatment (S)	≤ 10	≤ 30	≤ 30
Sum of all afterburning times (S) (10 flame treatments)	≤ 50	≤ 250	≤ 250
Afterburning and afterglowing of the samples after the second flame treatment (S)	≤ 30	≤ 60	≤ 60
Burning dripping	no	no	yes
Complete burning of the samples	no	no	no

BERNSTEIN enclosures have been classified as ABS UL 94 HB, PC UL 94 V2 and UP (unsaturated polyester resins) UL 94 V0.

CORROSION RESISTANCE

For better protection, BERNSTEIN offers CA enclosures with a special powder coating for applications with increased requirements. The salt content of the air and high humidity accelerate the corrosion behaviour of some materials. In accordance with the product standard DIN EN 62208, to which BERNSTEIN adheres, the resistance of the materials is tested with a salt spray test in a corrosive atmosphere. During the test the corrosive changes to the metallic enclosure material and the coating are investigated by cyclically applied loads using salt solutions and moist warm air.

We would be pleased to provide you with further information personally.

HALOGEN FREE

Halogens are a group of 6 chemical elements, whereby only the elements fluorine, chlorine and bromine are relevant for applications in electronic fields. Halogens are used as flame retardants in some plastics. However, in the event of fire, these elements may form corrosive and toxic compounds. As a result, interest in halogen-free products is growing steadily. BERNSTEIN uses halogen-free enclosure materials for the plastic enclosures of the CT and CP product families. The PUR seal used as standard at BERNSTEIN also contains no halogens.

UV RADIATION

Ultraviolet radiation covers the wavelength range from 100nm to 400nm and is the most energetic part of optical radiation. UV radiation is neither visible nor perceptible to humans. Due to the energy wealth of UV radiation, free radicals are formed in the plastic. The atmospheric oxygen binds with these radicals and the polymer oxidizes. However, in order to prevent oxidation in the CA series, BERNSTEIN's in-house coating system applies a special powder coating. The enclosures of the CP series are the preferred choice for applications with increased requirements.

MECHANICAL STRENGTH

For applications requiring increased strength, BERNSTEIN offers its range of CA and CP series enclosures. The mechanical strength of a material describes how much mechanical stress a material can withstand until it fails. A distinction is made between elastic deformation, plastic deformation, and fracture. Specific characteristics of mechanical strength are, for example, tensile strength, flexural strength, notched impact strength and compressive strength.

Notes

Diagrams. Sketches. Ideas.

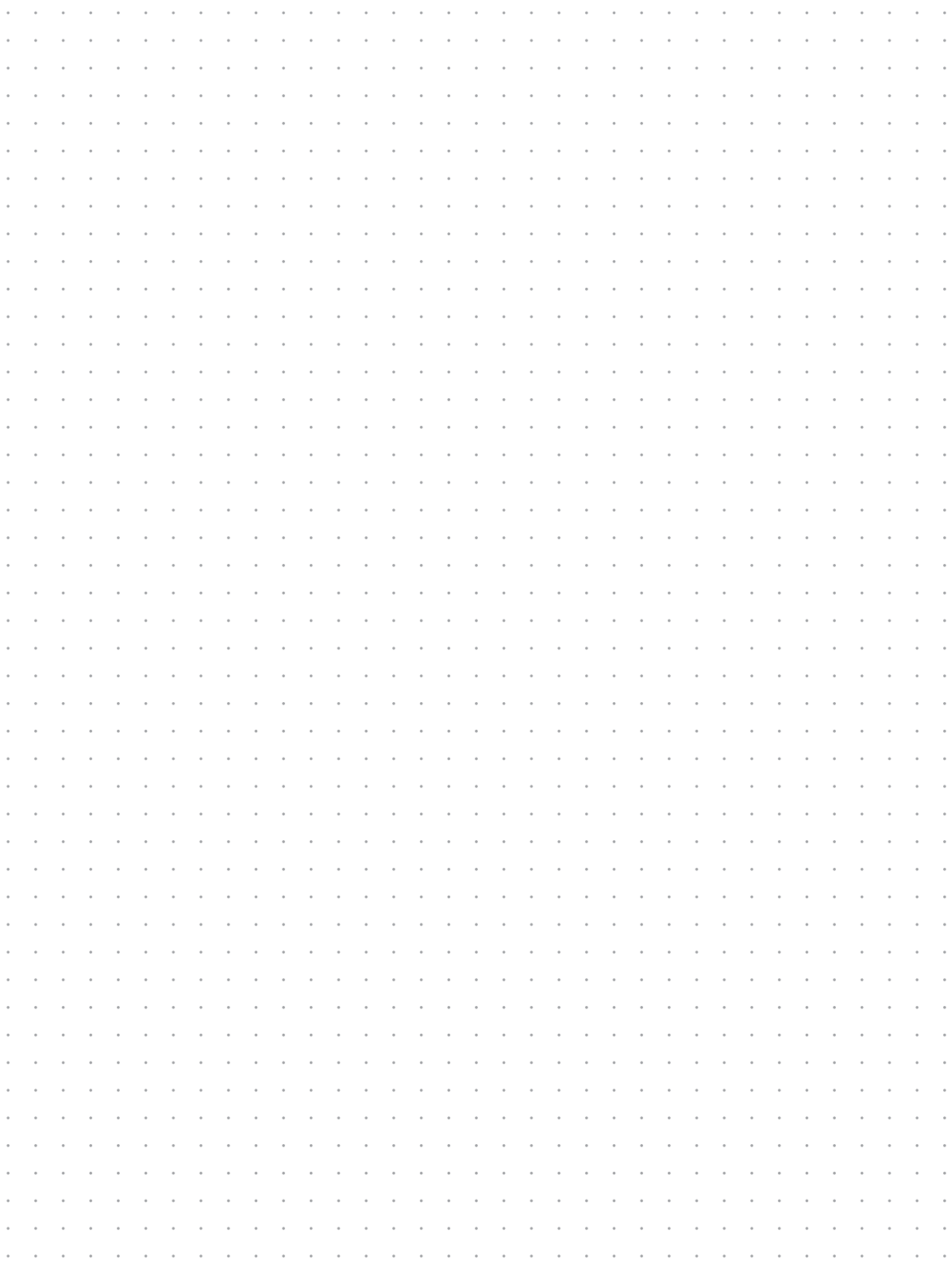



**We make
safety happen.**



**We keep your
visions safe.**

Contact

**International Headquarters
BERNSTEIN AG**
Hans-Bernstein-Str. 1
32457 Porta Westfalica
Phone +49 571 793-0
info@bernstein.eu
www.bernstein.eu

**China
BERNSTEIN Safe Solutions
(Taicang) Co., Ltd.**
Phone +86 512 81608180
info@bernstein.asia
www.bernstein.asia

**Denmark
BERNSTEIN A/S**
Phone +45 7020 0522
info.denmark@bernstein.eu
www.bernstein.dk

**Italy
BERNSTEIN S.r.l.**
Phone +39 035 4549037
sales@bernstein.it
www.bernstein.it

**France
BERNSTEIN S.A.R.L.**
Phone +33 1 64 66 32 50
info.france@bernstein.eu
www.bernstein.fr

**Austria
BERNSTEIN GmbH**
Phone +43 2256 62070-0
office@bernstein.at
www.bernstein.at

**United Kingdom
BERNSTEIN Ltd**
Phone +44 1922 744999
sales@bernstein-ltd.co.uk
www.bernstein-ltd.co.uk

**Switzerland
BERNSTEIN (Schweiz) AG**
Phone +41 44 775 71-71
info.schweiz@bernstein.eu
www.bernstein-schweiz.ch